

RONDA startech 4000

Multifunctions with Big Date,
Alarm, 2nd Time Zone

Caliber 4220.B – 12½'''

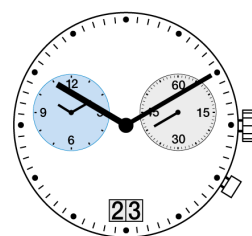

Product Specifications

Analog quartz movement

Line

startech

Caliber

4220.B

Size

12½'''

Version Swiss Made

7 Jewels / gold plated

Standard battery life

54 months

Hand fitting height

2

Features

- Repairable metal watch movement
- Very long battery life
- Power saving mechanism with pulled out stem: Reduction of consumption approximately 70%
- Very easy handling by one pusher

Functions

- 2 eyes
- Multifunction
- Second time zone
- Big date
- Small second

Technical Specifications

Diameter Total	28.60 mm
Case fitting	28.00 mm
Movement height	4.40 mm
Height over standard battery	4.40 mm
Movement rest	0.60 mm
Height over stem	1.90 mm
Length of stem travel	0.90 mm
Force to push the stem for screwed crown	10 / 15 N
Stem thread	0.90 mm
Standard battery	395
Standard battery life	54 months
Battery voltage	1.5 V
Current consumption – typical	1.32 µA (Date Mechanism not in Gear)
Current consumption – maximum	1.65 µA (Date Mechanism not in Gear)
Useful torque second – typical	6 µNm
Useful torque minute – typical	300 µNm
Operating temperature	0 - 50 °C
Instantaneous rate	-10/ +20 sec/month
Resistance to magnetic fields	18.8 Oe
Resistance against shock	NIHS 91-10



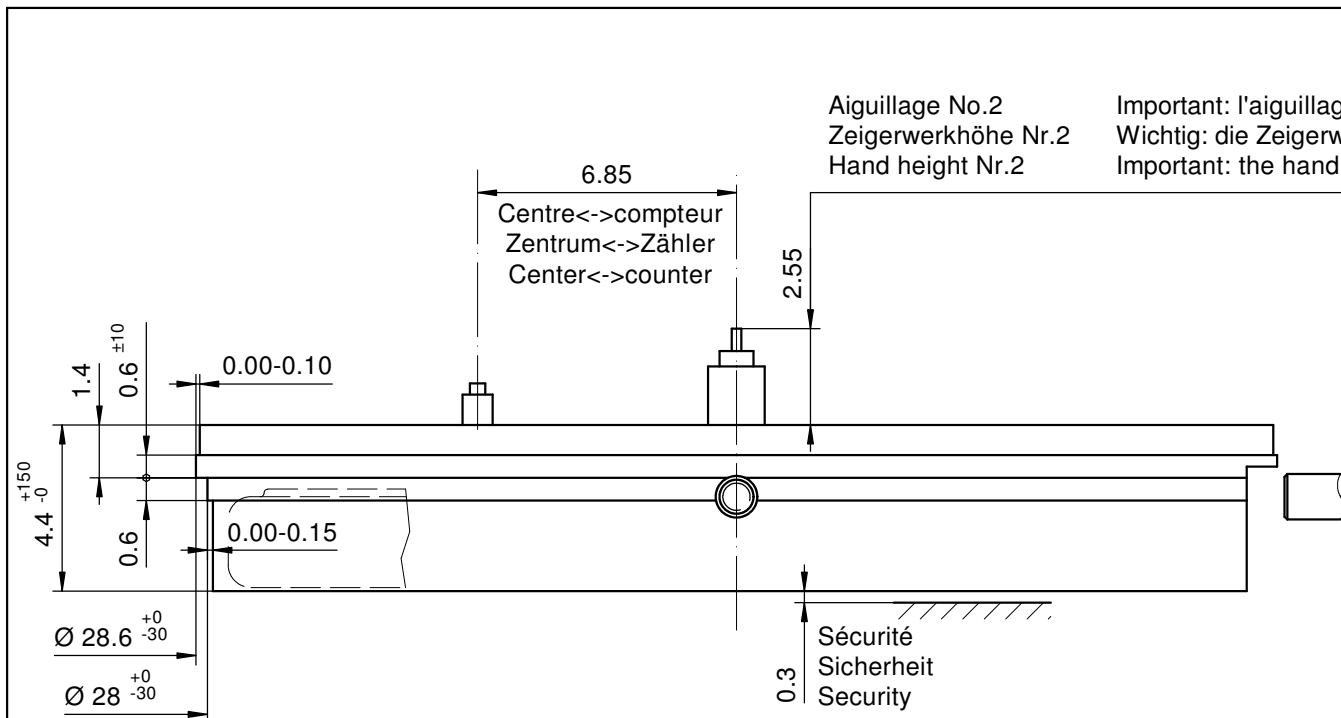

Aiguillage No.2
Zeigerwerkhöhe Nr.2
Hand height Nr.2

Important: l'aiguillage peut varier selon le modèle
Wichtig: die Zeigerwerkhöhe kann bei verschiedenen Modellen unterschiedlich sein
Important: the hand height can vary between different models

Sécurité entre l'aiguille des secondes et le verre: 0.30mm
Sicherheit zwischen Sekundenzeiger und Glas: 0.30mm
Security between second hand and glass:

Le cadran doit être tenu par la boîte
Das Zifferblatt muss durch die Schale gehalten werden
The dial must be hold by the case

La course du poussoir doit être limitée dans le poussoir lui-même. Sa position poussée doit être contrôlée.

Die Weglänge des Drückers ist im Drücker selbst zu begrenzen. In der gedrückten Stellung ist seine Position zu kontrollieren

The way of the pusher has to be limited in the pusher itself. Its position must be checked while pushed in.

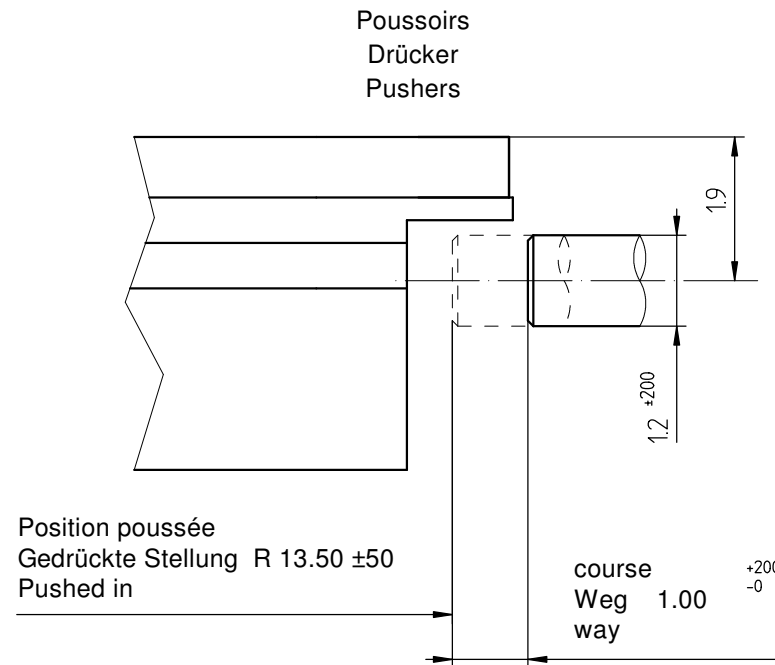

Côté fond de boîte
Seite Gehäuseboden
Case back side

Position pour extraire la tige
Position zum Entfernen der Stellwelle
Position to remove the stem

Pile Batterie (395) Ø 9.50 x 2.60mm
Battery

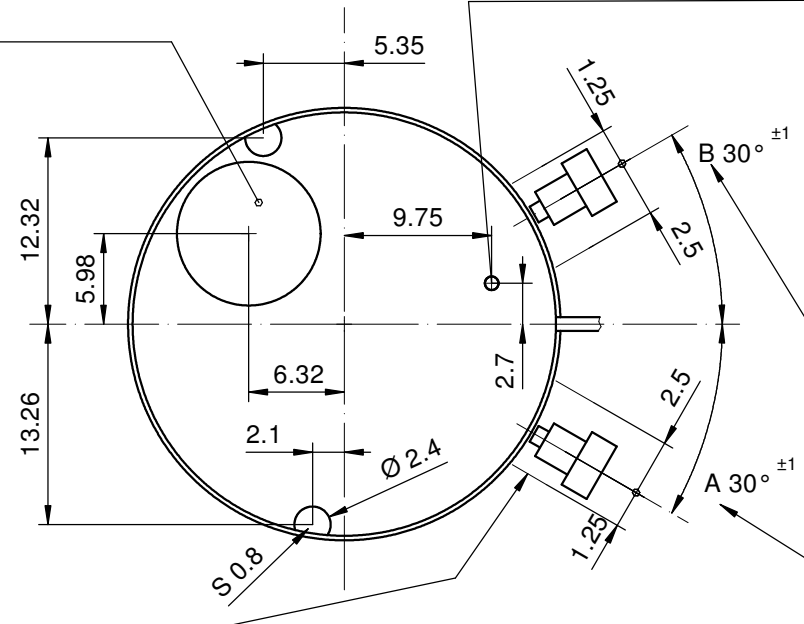

Seulement 1 poussoir est nécessaire
Nur 1 Drücker wird benötigt
Only 1 pusher is required

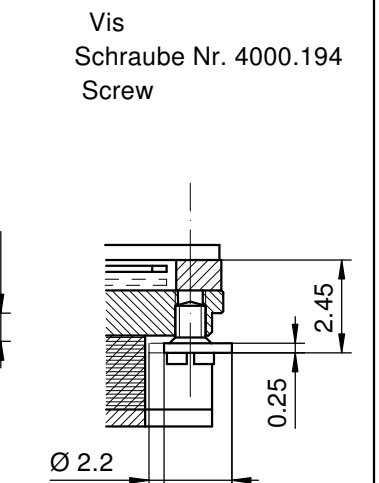
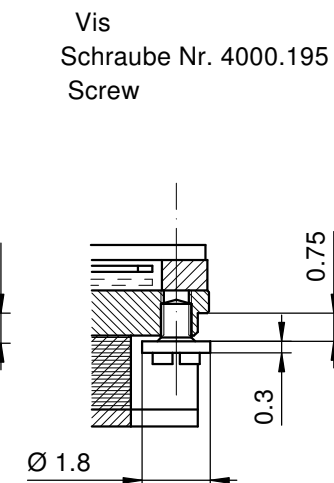
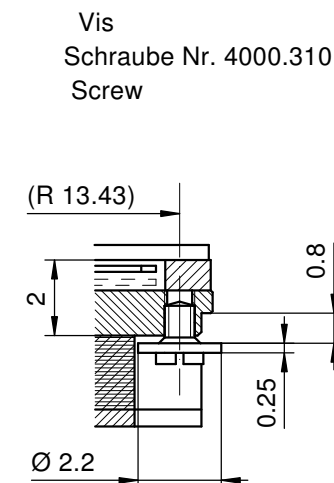
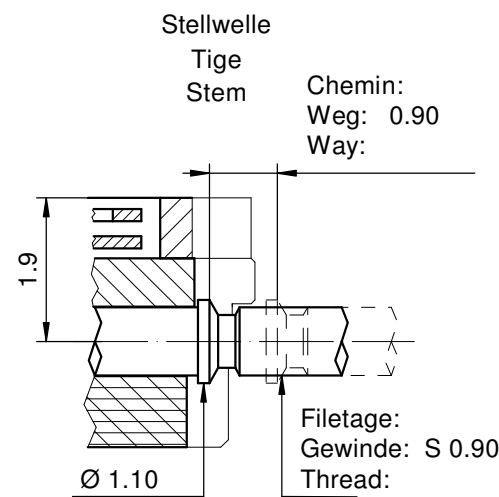

Dégagement cercle d'entourage pour poussoir
Freistellung Gehäuseering für Drücker
Opening movement holder for pusher

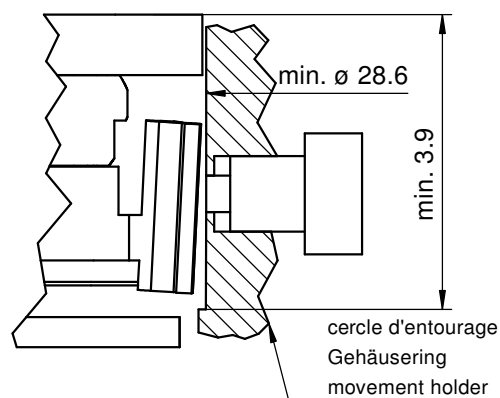

L'angle indiqué pour la direction du poussoir et la position doivent être respectés.
Pour un angle de 0° des poussoirs A et B, voir plan 5000.345

Der angegebene Winkel für die Drückerrichtung und die Position müssen eingehalten werden.
Für einen Drückerwinkel von 0° bei A und B, siehe Zeichnung 5000.345

The indicated angle of the pusher direction and the position must be fulfilled. For pusher angles of 0° (pusher A and B), see drawing 5000.345.

Cage
Urwerkgestell 12½"
Frame

RONDA 4220.B

Issued	02 Mär 2004	mk
Modified	05 Sep 2016 ÄÄ 34777	dh
Released	YES	
Tolerance	+/- 20 µm	
Scale	10 : 1 (5 : 1) (A3H)	
Sous réserve de modifications Änderungen vorbehalten Modifications reserved		
No.	5000.348	02

Angle Winkel Angle	30°	
Ø Dp	b	
1.00	13.50	
1.10	13.50	
1.20	13.50	
1.30	13.50	
1.40	13.50	

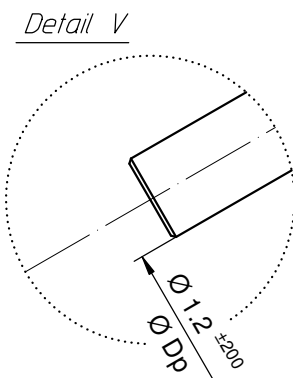
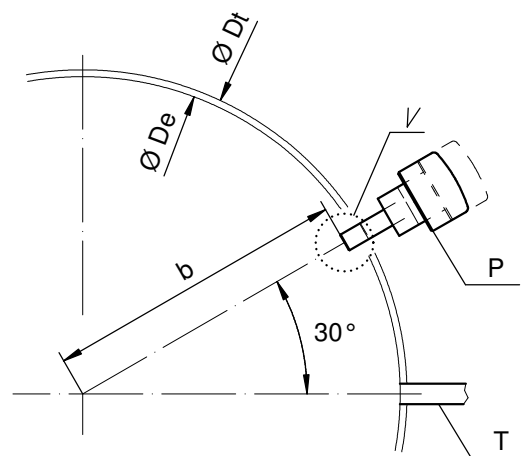

Angle Winkel Angle	0°	
Ø Dp	a	b
1.30	7.40	11.43
1.40	7.45	11.40

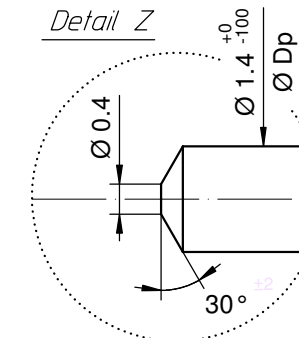
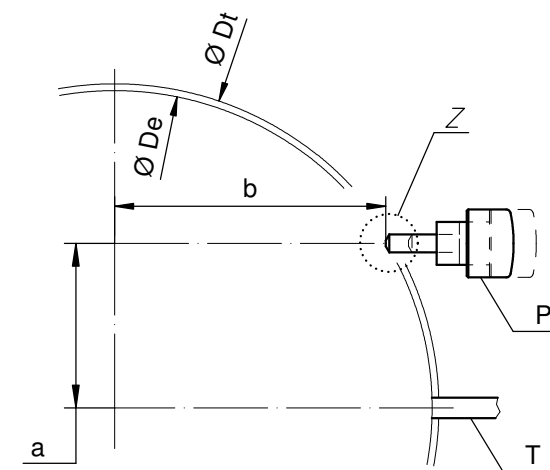

Angle Winkel Angle	20°	
Ø Dp	a	b
1.30	2.57	13.22
1.40	2.59	13.21

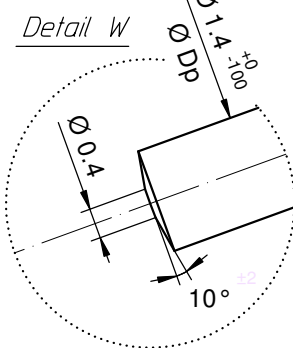
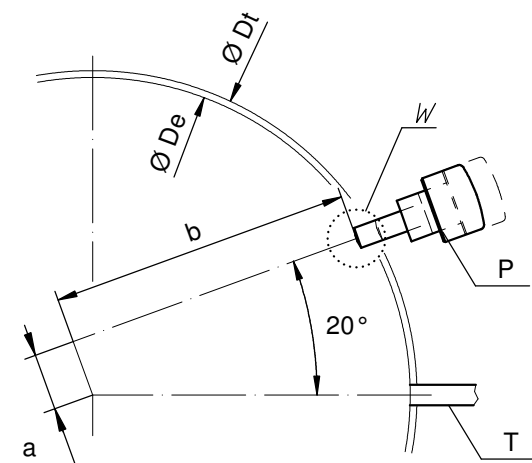

Ø De: diamètre d'encageage
Durchmesser der Gehäusepassung
fitting-diameter

Ø Dp: diamètre du poussoir
Drückerdurchmesser
pusher-diameter

Ø Dt: diamètre total
Totaldurchmesser
total-diameter

P: poussoir en position poussée
Drücker in gedrückter Stellung
pusher in pressed position

T: tige de mise à l'heure
Stellwelle
stem

Angle Winkel Angle	15°	
Ø Dp	a	b
1.30	3.83	12.92
1.40	3.86	12.91

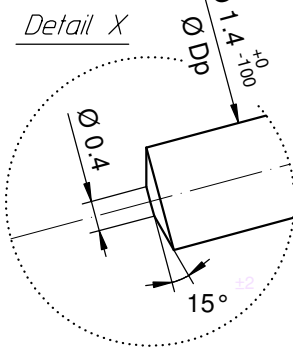
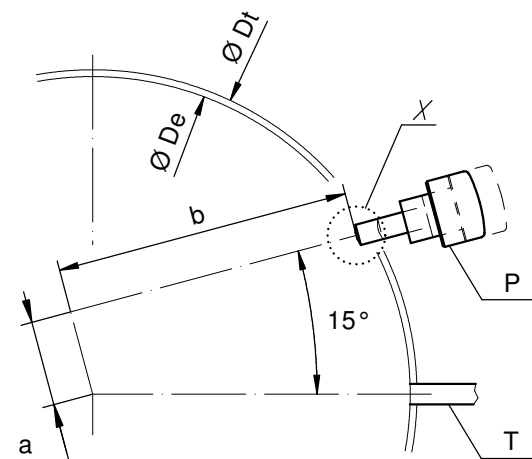

Angle Winkel Angle	10°	
Ø Dp	a	b
1.30	5.06	12.52
1.40	5.10	12.50

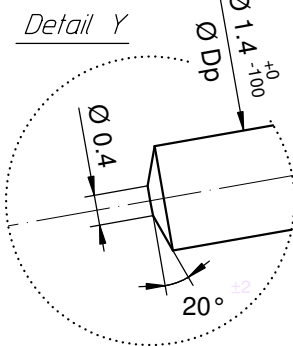
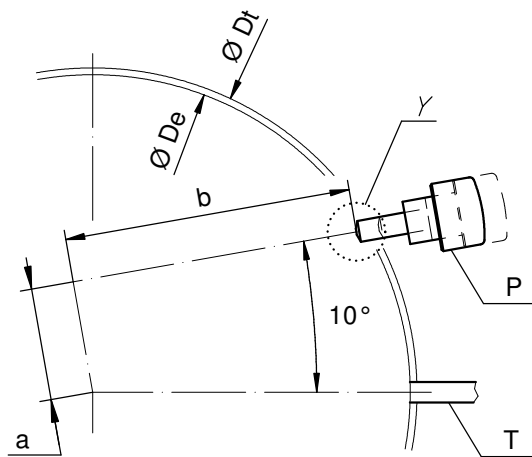

Angle des poussoirs A et B
Winkel der Drücker A und B
Angle of pusher A and B

RONDA 4xxx.x, 5xxx.x

Issued	06 Sep 2004	mk
Modified	30.März 2005 ÄA 1784	mk
Released	YES	
Tolerance	+/- 20 µm	
Scale	10 : 1 (5 : 1) (A3H)	
Sous réserve de modifications Änderungen vorbehalten Modifications reserved		
No.	5000.345	01

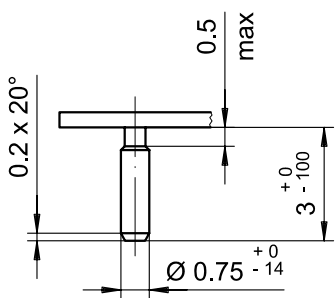
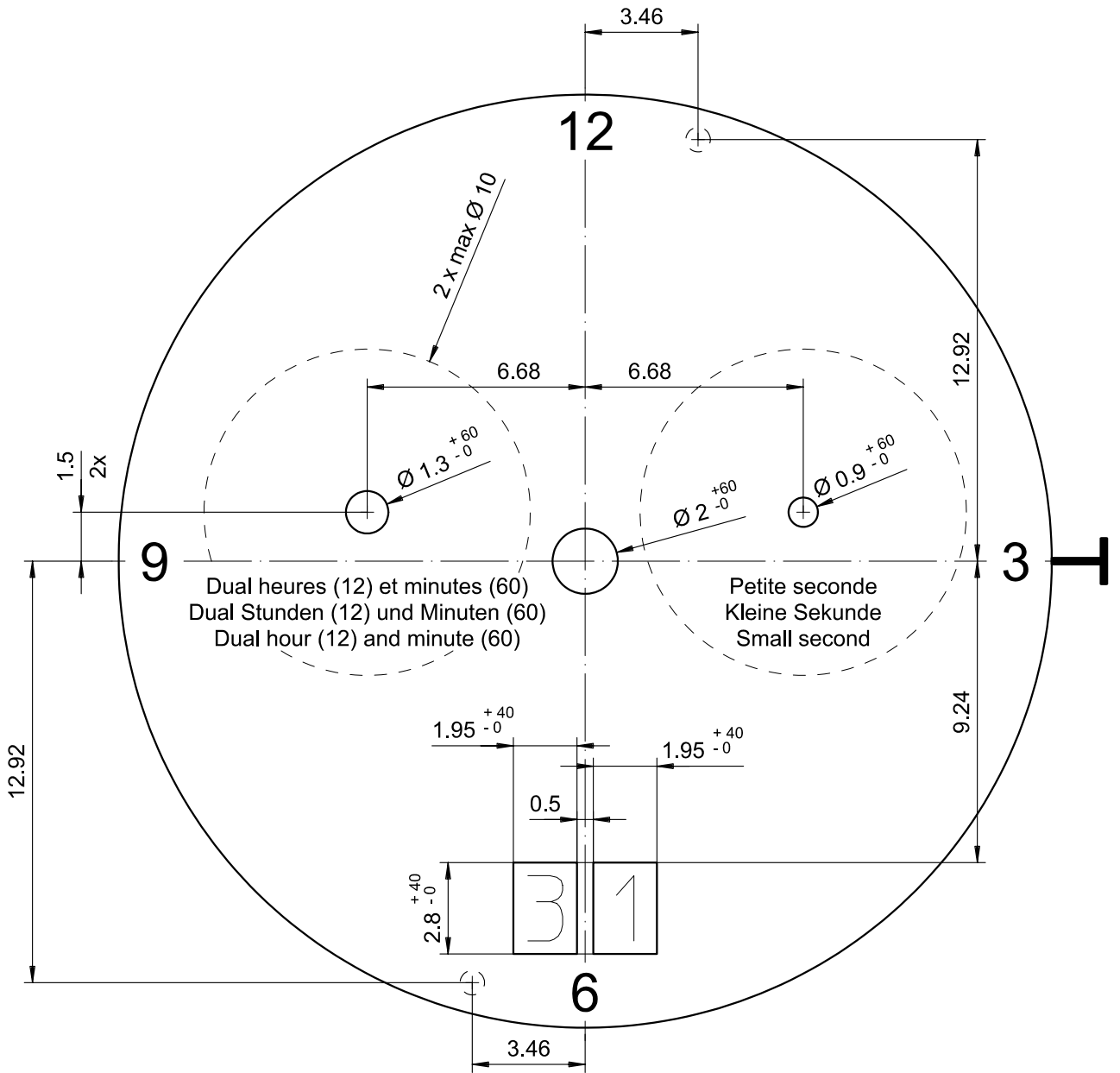

Epaisseur du cadran selon hauteur de l'aiguillage
 Zifferblattdicke gemäss Zeigerwerkhöhen
 Dial thickness according to hand fitting heights

Tige	Date
Stellw.	Datum
Stem	Date
3H	6H

Cadran Zifferblatt Dial	12½"	Issued	13 Dez 2006	cw
		Modified	15.Dez.2006 ÄÄ ----	cm
		Released	YES	
		Tolerance	+/- 20 µm	
		Scale	5 : 1 (A4V)	
RONDA	4220.B	Sous réserve de modifications Aenderungen vorbehalten Modifications reserved		
		No.	5010.698	01

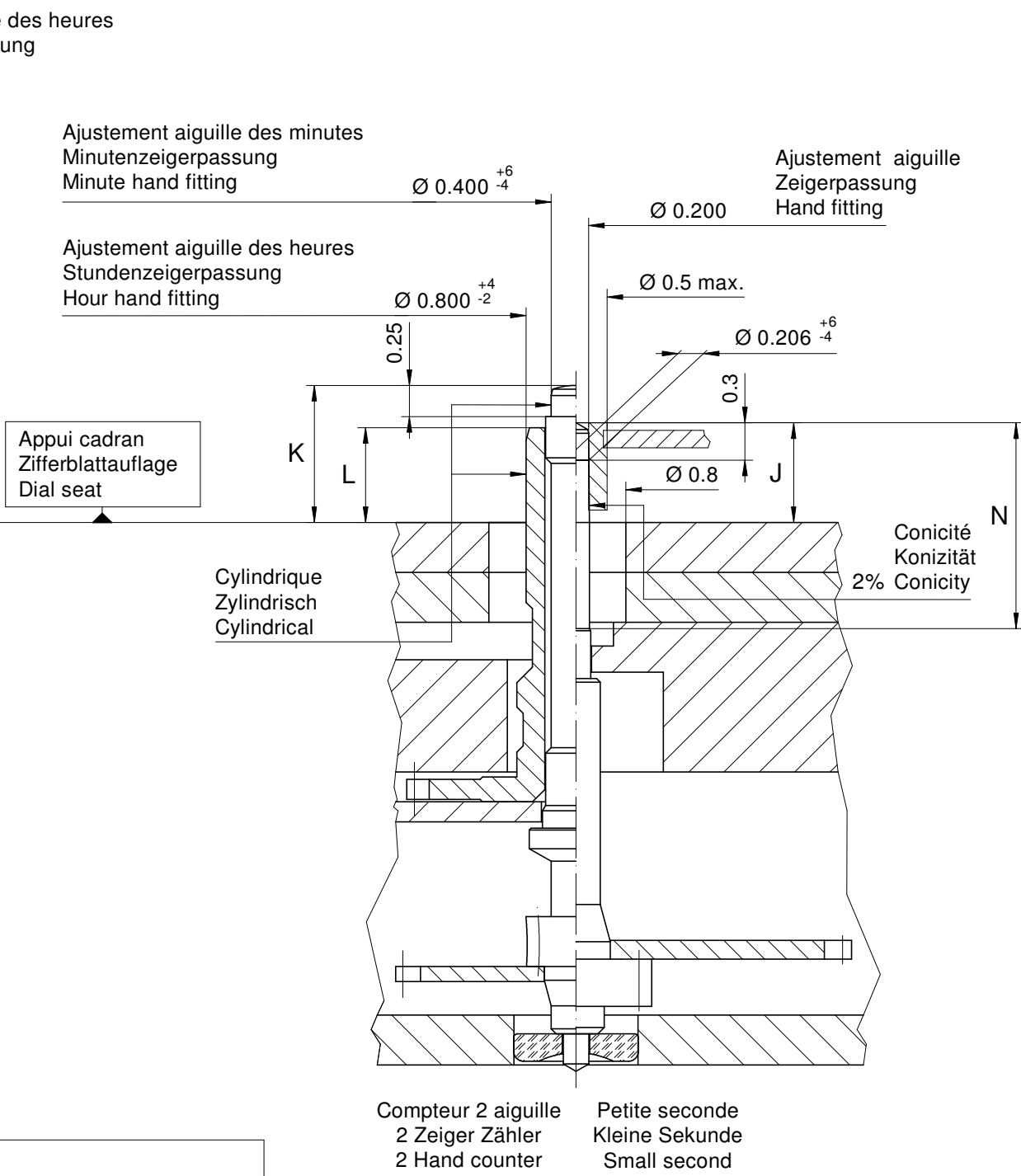
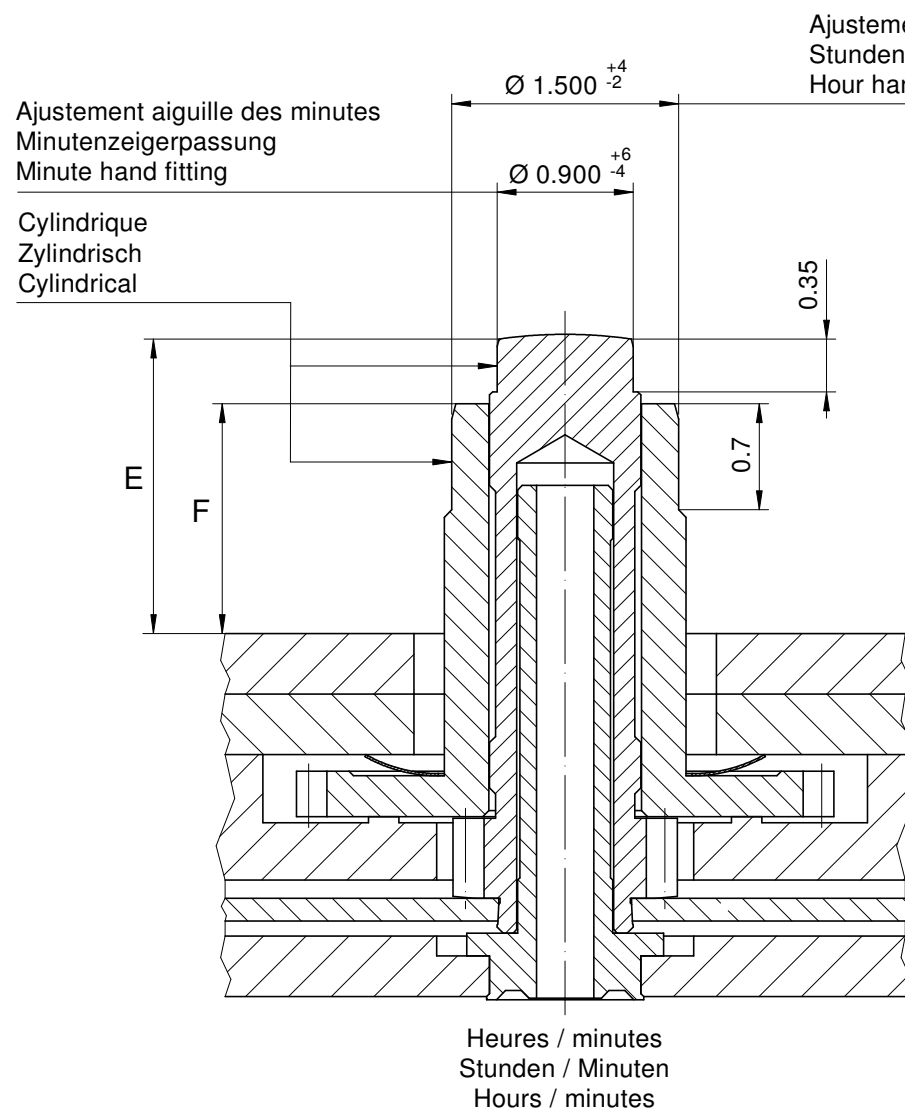

Aiguillages Zeigerwerkhöhe Hand fitting height						
Dépassement Höhe über Zifferblattauflage Height over dial seat						
No	Chaussée Minutenrohr Cannon-pinion	Roue des heures Stundenrad Hour wheel	Compteur 2 aig. 2 Zeiger Zähler 2 Hand counter		Petite seconde Kleine Sekunde Small second	J
			K	L		
2	E	F	N	K	L	J
	1.95	1.52	1.65	1.10	0.76	0.80
-						

Aiguillages Zeigerwerkhöhe Hand fitting height						
Peinture comprise / inkl. Farbe / Paint included						
Epaisseur maximum du cadran Maximale Zifferblattdicke Maximum dial thickness						
No	Sous l'aiguille des minutes Unter Minutenzeiger Under minute hand	Sous l'aiguille des heures Unter Stundenzeiger Under hour hand	Compteur 2 aig. 2 Zeiger Zähler 2 Hand counter		Sous l'aiguille de petite seconde Unter kleine Sekundenzeiger Under small second hand	Epaisseur des aiguilles Zeigerdicke Hands thickness
			0.70	0.40		
2	1.50	1.10	0.70	0.40	0.40	0.15
-						

	mg max.	µNm max.	gmm ² max.	N max.	Aig. des minutes Minutenzeiger Minute hand	Aig. des heures Stundenzeiger Hour hand	Compteur 2 aiguille 2 Zeiger Zähler 2 Hand counter		Aig. petite secondes Kleine Sekundenzeiger Small second hand	Lors de la pose d'aiguilles, le mouvement doit être soutenu. Beim Zeigersetzen muss das Werk abgestützt werden. The movement needs to be supported for hand setting.
					10	10	10	10		
	30	0.80	-	40	10	10	10	10	10	Masse / Masse / Weight *
	30	0.80	-	40	0.03	0.03	0.03	0.03	0.07	Balourd / Unwucht / Unbalance *
	-	-	1.0	-	1.0	-	1.0	-	0.4	Inertie / Massenträgheit / Inertia *
	40	40	30	30	30	30	30	30	30	Force de chassage / Aufpresskraft / Force

**Aiguillages
Zeigerwerkhöhe 12½"
Hand fitting heights**

RONDA 4120.B, 4220.B

Issued	14 Nov 2003	mk
Modified	15 Okt 2014 ÄÄ 13275	dh
Released	Yes	
Tolerance	µm	
Scale	20 : 1 (A3H)	
Sous réserve de modifications Änderungen vorbehalten Modifications reserved		
No.	3316.083	04

* En cas de données différentes, veuillez contacter le service après-vente

* Bei abweichenden Werten, bitte technischen Kundendienst anfragen

* In case of different values, please contact the customer service

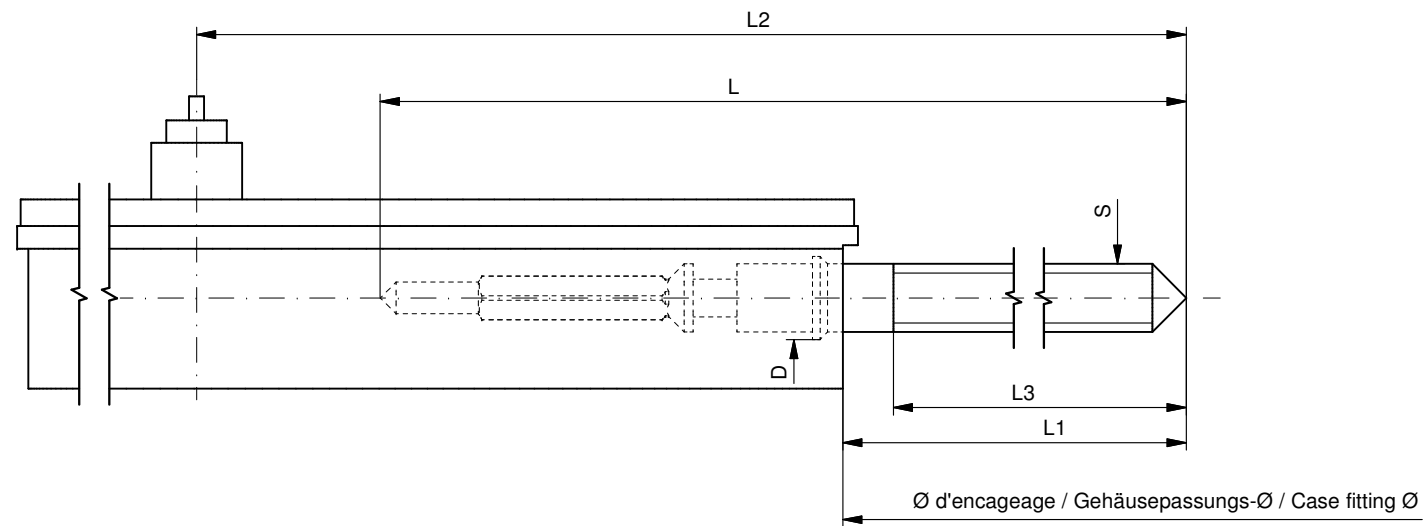

Tige de travail (intégrée dans le mouvement)
 Arbeitstellwelle (im Werk eingebaut)
 Working stem (implemented in the movement)

No. d'article Artikelnummer Part number	L	L1	L2	L3	S	D
3000.177.CO	20.00	10.23	24.23	10.15	0.90	1.10

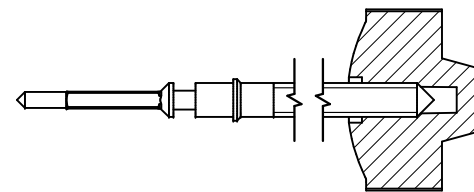

Couleur de la couronne Kronenfarbe Crown color	bleu foncé dunkelblau dark blue
Code	UN 5002

Tige (normale) / Stellwelle (normal) / Stem (normal)

No. d'article Artikelnummer Part number	L	L1	L2	L3	S	D
3000.177	20.00	10.23	24.23	10.15	0.90	1.10
3000.191	32.00	22.23	36.23	22.15	0.90	1.10

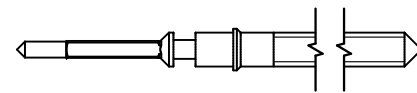

Couronne normale
 Normale Krone
 Normal crown

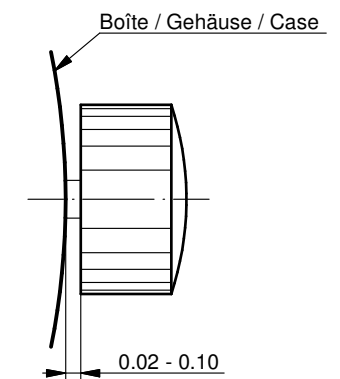

Couronne vissée
 Geschraubte Krone
 Screwed crown

Force ⇐ min. Kraft ⇐ min. Force ⇐ min.	10 N
Force ⇐ max. Kraft ⇐ max. Force ⇐ max.	15 N

Rallonge de tige / Stellwelle Verlängerung / Stem extension

No. d'article Artikelnummer Part number	L4	L5 (min)	L6	S1	S2	D1
3000.040	12.00	1.90	2.60	0.90	0.90	1.35

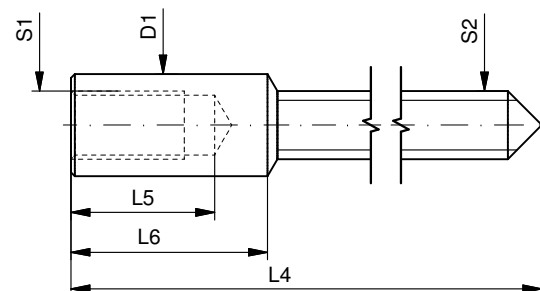

Tige (dimensions / forces)
 Stellwelle (Dimensionen / Kräfte)
 Stem (dimensions / forces)

RONDA

4002.B, 4003.B, 4120.B,
 4210.B, 4220.B

Issued	05 Sep 2012	ds5222
Modified	17 Mär 2017 ÄA 34582	mg5224
Released	YES	
Tolerance	---	
Scale	10:1 (A3)	

Sous réserve de modifications
 Änderungen vorbehalten
 Modifications reserved

No.	5030.018	02
-----	----------	----



Movement holder
Removing setting stem
H5XXX.1T



Movement holder
Setting hands
H5XXX.1A

Fitting dial and hands

- Crown in position II
- Wind crown, until date 02 appears
- Crown in position III
- Wind hour hand forwards, until date changes to 03
- Remove working stem
- Fit dial
- Point all hands towards 12 o'clock
- Set time
- Crown in position II
- Set date
- Install second time zone**
- Crown in position I

Date switching duration:

First and tenth digit discs

~2hrs

****Installing second time zone**

- Activate pusher B for at least 2 seconds
(You are in active mode, if small minute hand jumps forward 1 min.)
- Install second time zone, using pusher B:
 - Short press (< 1 sec.) → +1 minute
 - Medium press (1-2 secs.) → +1 hour
 - Long press (> 2 secs.) → continuous time display

Details: See Instruction Manual

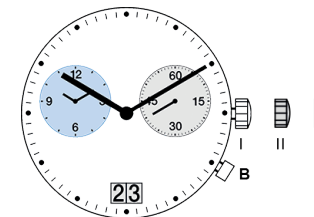
General Instructions

Removing the setting stem can only be effected in Pos. I.

The use of supporting screws is essential when mounting the hands.

Permitted hand setting strengths:

Hr / min. hands: <40N

Other hands: <30N

During quick date correction (setting stem in position II), a date switching speed of 5 d/s must not be exceeded.

You have decided to buy a watch, which was assembled by a watchmaker using a Ronda movement. Please note that no watches are produced or distributed under the Ronda brand.

In case of repairs, guarantee claims and questions concerning the functioning of a watch, purchasers and consumers should contact their retailer or the watch manufacturer, for which the relevant information can be found in the sales or guarantee documentation provided with the watch.

Description of the display and control buttons

Display elements 4210.B

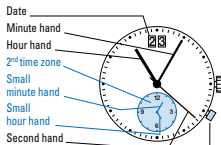

Control buttons



Display elements 4220.B

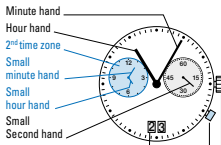

Control buttons

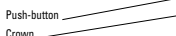

01

4210.B Second 4220.B Small second

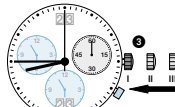
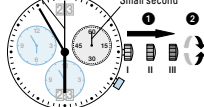

02

Setting the time

- 1* Pull out the crown to position III (the watch stops).
- 2 Turn the crown until you reach the correct time 8:45.
- 3* Push the crown back into position I.

Please note:

* In order to set the time to the exact second, 3 must be pulled out when the second hand is in position «60». Once the hour and minute hands have been set, 3 must be pushed back into position I at the exact second.

Setting the date (quick mode)

- 1 Pull out the crown to position II (the watch continues to run).
- 2 Turn the crown until the correct date 01 appears.
- 3 Push the crown back into position I.

Please note:

During the date changing phase between approx. 9 PM and 12 PM, the date must be set to the date of the following day.

An extreme acceleration in setting the date with quick mode can induce a false date indication. The synchronization is re-established by setting the date from 01 till 31 (crown in position II).

03

Setting the date/time

Example:

- Date / time on the watch: 17 / 1:25 AM
- Present date / time: 04 / 8:30 PM

- 1 Pull out the crown to position II (the watch continues to run).
- 2 Turn the crown until yesterday's date appears 03.

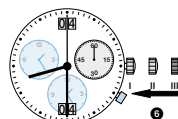
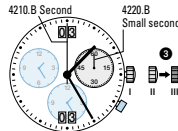
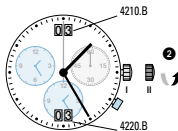

04

- 3* Pull out the crown to position III (the watch stops).
- 4 Turn the crown until the correct date 04 appears.
- 5** Continue to turn the crown until the correct time 8:30 PM appears.

6 Push the crown back into position I.

Please note:

* To set your watch to the exact second, please refer to the chapter entitled «setting the time».

** Please observe the AM/PM clock rhythm.

Setting the 2nd time zone

4210.B



4220.B

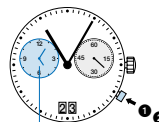

Any 2nd time zone can be set using the small hour hand and small minute hand.

1 **Activation:** Press the push button for at least 2 seconds. As soon as the small minute hand jumps forward one minute, this mode of operation is activated.

2 **Brief pressing:** (less than 1 second) Moves forward individual minutes.

Medium pressing: (1 to 2 seconds) Moves forward 1 hour.

Long pressing (longer than 2 seconds) The time zone is moved forward until the push button is released.

Please note:

If the push button is not pushed for ten seconds, the setting mode is deactivated. Please see point no 1 for activation.



05





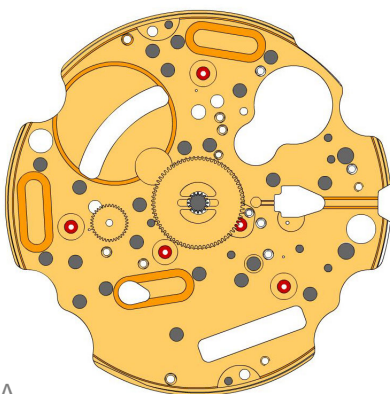
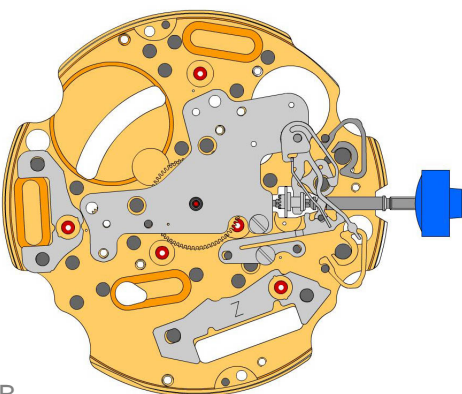
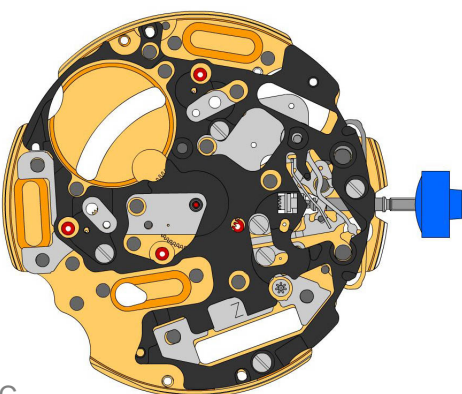













Battery type: 395 / SR927SW
Accuracy: +20 / -10 seconds per month







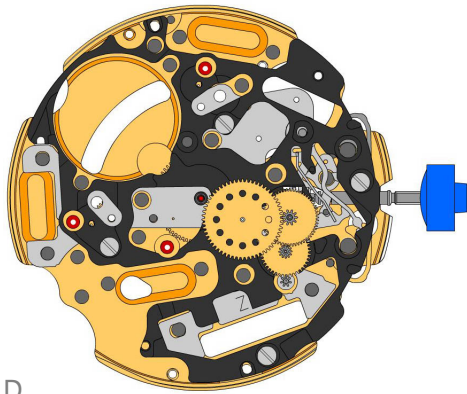

A

B

C

2000.574.G 1.		Main plate
3305.290.CO 2.		Cannon pinion with driver (Aig.2, closed)
3301.243 3.		Hour wheel (counter 12h)





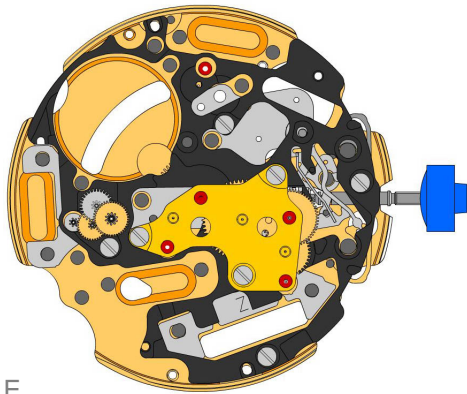

2030.024.CO 4.		Centre bridge Centre bridge held by 1 screw 4000.250.
4000.250 5.		Screw
3001.055.FI 6.		Sliding pinion
3000.177.CO 7.		Setting stem
3017.049 8.		Setting lever
3905.049 9.		Setting lever jumper (3 positions) Setting lever jumper tenue par 1 vis 4000.250.
4000.250 10.		Screw
3015.081 11.		Yoke (3 positions)
3905.067 12.		Yoke spring Tensioning the spring arm.
3406.030 13.		Pusher jumper B Put the grey jumper between the two posts on the further side.
3406.038 14.		Pusher jumper A Put the yellow jumper between the two posts on the closer side.
3622.040 15.		Stator Mark [Z] on stator.
3622.039 16.		Stator (counter 6h, 9h, chrono)

3603.079 17.		Plastic bracket Plastic bracket held by 1 screw 4000.250.
4000.250 18.		Screw
3715.094.RK 19.		Rotor







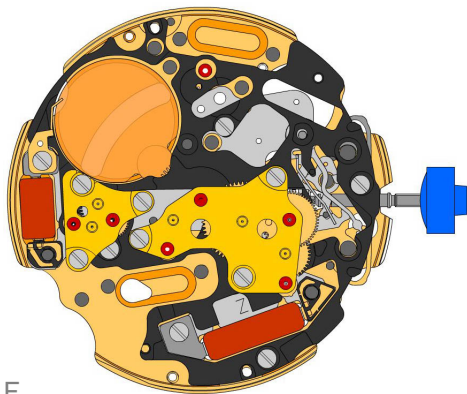

D

3147.046.CO 20.		Intermediate wheel
3136.142.CO 21.		Second wheel (long)
3122.056.CO 22.		Third wheel
2020.148.G 23.		Train wheel bridge Train wheel bridge held by 3 screws 4000.250.
4000.250 24.		Screw





E

3715.095.RK 25.		Rotor
3147.048.CO 26.		Intermediate wheel (counter)
3007.055.CO 27.		Minute wheel (counter 12h)
3402.007.CO 28.		Minute counting wheel (12h)
2020.149.G 29.		Counter train wheel bridge Counter train wheel bridge held by 3 screws 4000.250.
4000.250 30.		Screw

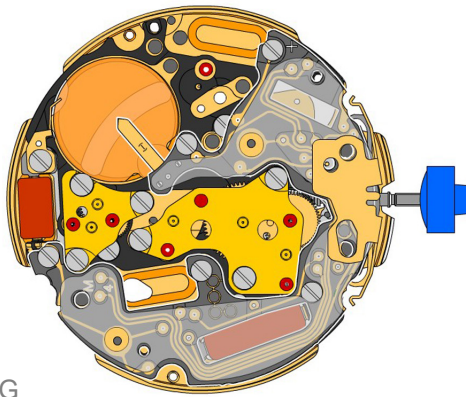



F

3621.053.RK 31.		Coil Attention: Please hold the coil only on the grey coil core. Coil held by 1 screw 4000.250.
3621.054.RK 32.		Coil (counter 9h, chrono) Attention: Please hold the coil only on the grey coil core.
3601.118 33.		Contact strip Contact strip held by 1 screw 4000.250.
4000.250 34.		Screw
3503.054 35.		Tube
3503.054 36.		Tube
3603.034 37.		Battery insulator

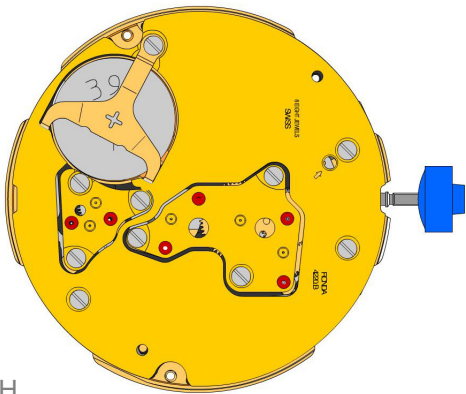







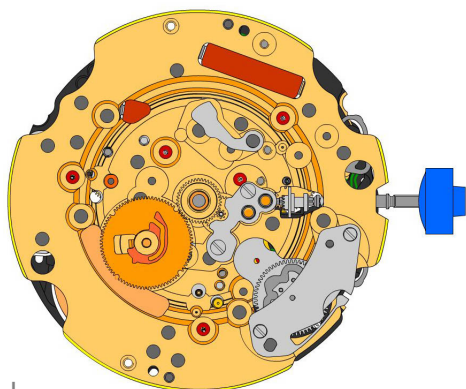
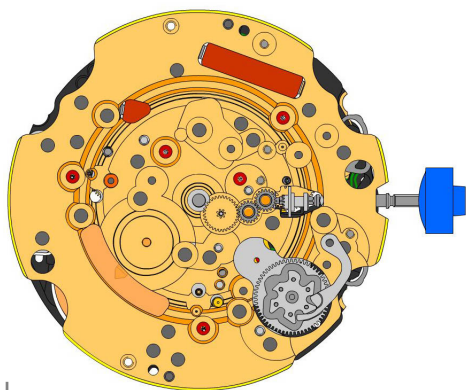





G

3612.144.4220 38.		Electronic module Electronic module held by 5 screws 4000.248. Electronic measurements may be realised now.
4000.248 39.		Screw
3603.069 40.		Circuit insulator
3601.107.G 41.		Pusher contact spring





H



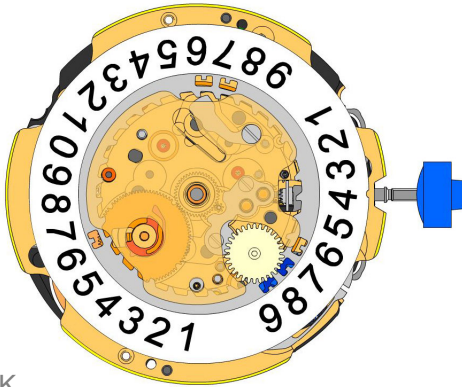
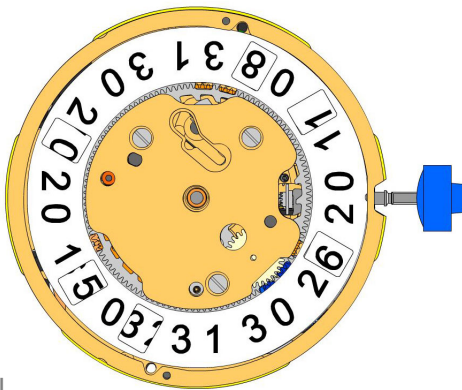

2130.138.G.M01.4220B 42.		Electronic module cover Electronic module cover held by 3 screws 4000.250.
3600.010.HGF 43.		Battery 395
3601.109.G 44.		Bridle + Bridle held by 1 screw 4000.250.
4000.250 45.		Screw







2000.574.G 46.		Main plate
3004.164 47.		Setting wheel
3004.164 48.		Setting wheel
3007.054.CO 49.		Minute wheel
2130.143 50.		Minute train bridge Minute train bridge held by 2 screws 4000.305.
4000.305 51.		Screw
3004.227 52.		Tens indicator driving wheel The short tooth of the tens indicator driving wheel must point to the center of the movement.
3500.075 53.		Tens jumper
2130.142 54.		Tens jumper maintaining plate Tens jumper maintaining plate held by 2 screws 4000.306. Tensioning the spring arm.
4010.306 55.		Screw
3301.242 56.		Hour wheel (Fig.2)
3315.016 57.		Friction spring
3004.224.CO 58.		Date indicator driving wheel
3500.049 59.		Date jumper

K

L

3504.214.AD.1.A 60.		Units indicator (standard) Nick of the indicator at 3 o'clock.
3147.054 61.		Tens intermediate wheel
2130.141 62.		Date indicator maintaining plate Date indicator maintaining plate held by 1 screw 4000.250.
3905.070 63.		Date jumper spring Insert the date jumper spring in the provided opening.

3504.215.AD.1.A 64.		Tens indicator (standard) Nick of the indicator at 3 o'clock
2130.140.G 65.		Date mechanism maintaining plate Date mechanism maintaining plate held by 2 screws 4000.250.
4000.250 66.		Screw
3506.072.G 67.		Dial support

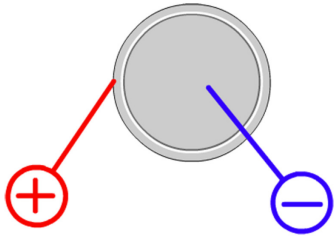
8200 68.		Moebius 8200
9014 69.		Moebius 9014
124 70.		Jismaa 124
9020 71.		Moebius 9020



Battery	395
Voltage	1.55 V

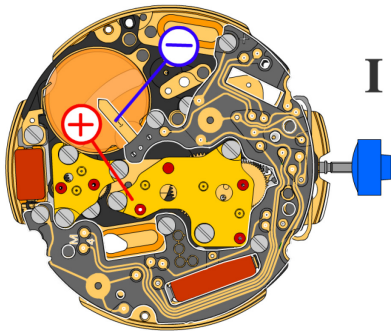

*Setting stem in position I, calendar not in gear,
60 s measuring interval for rate and consumption:*

Typical consumption	1.32 μA
Maximal consumption	1.65 μA
Rate	-10s/M. .. +20s/M.
Lower working voltage limit	1.20 V

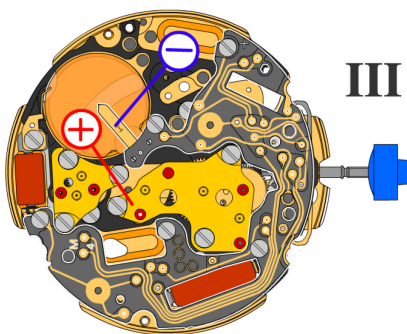

Setting stem in position III, 60 s measuring interval:

Typical consumption	0.10 μA
Maximal consumption	0.30 μA

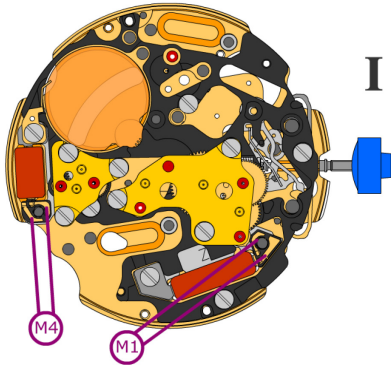

Coil resistance M1 **1.90 kΩ .. 2.10 kΩ**

Coil resistance M4 **1.68 kΩ .. 1.88 kΩ**

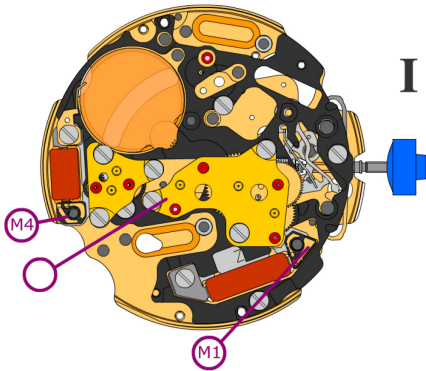



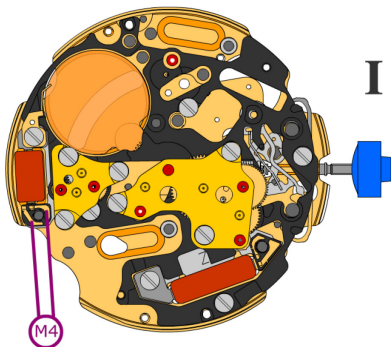





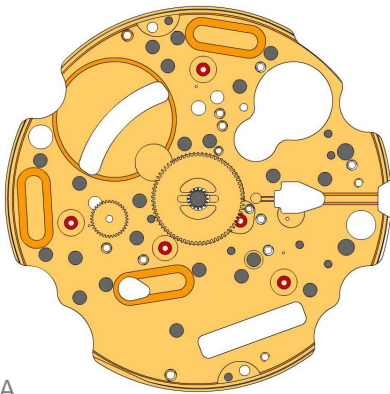
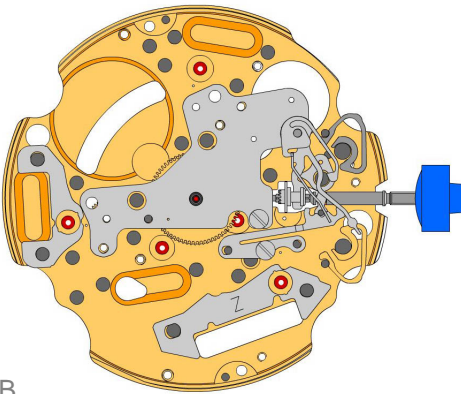
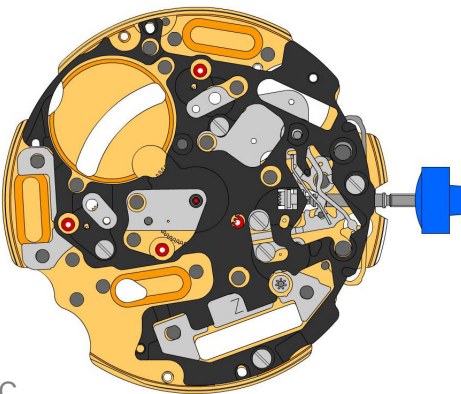











Coil isolation M1/M4 **∞ kΩ**







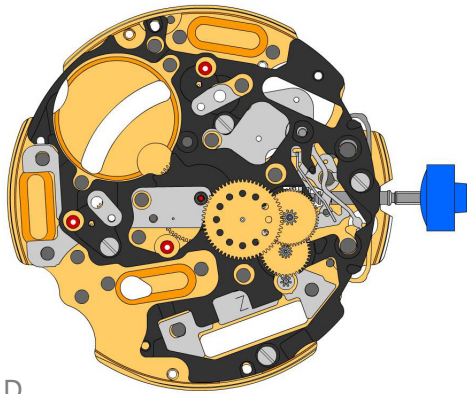

Signal generator (4.9 ms, 8 Hz):

Lower working voltage limit M4 **1.20 V**





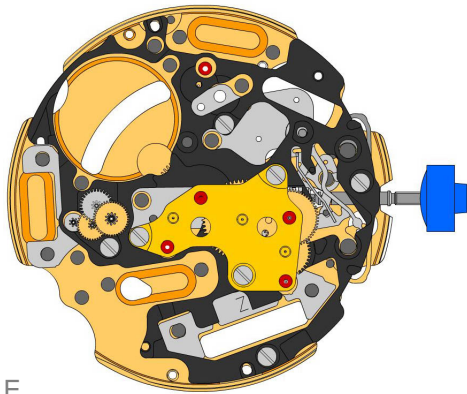

A

B

C

2000.574.G 1.		Main plate
3305.290.CO 2.		Cannon pinion with driver (Aig.2, closed)
3301.243 3.		Hour wheel (counter 12h)
2030.017.CO 4.		Centre bridge Centre bridge held by 1 screw 4000.250. Parts 2030.017.CO, 3004.223 and 3500.059 must be exchanged together.
4000.250 5.		Screw
3001.055.FI 6.		Sliding pinion
3000.177.CO 7.		Setting stem
3017.049 8.		Setting lever
3905.049 9.		Setting lever jumper (3 positions) Setting lever jumper tenue par 1 vis 4000.250.
4000.250 10.		Screw
3015.081 11.		Yoke (3 positions)
3905.067 12.		Yoke spring Tensioning the spring arm. Parts 3015.081 and 3905.067 must be exchanged together.
3406.030 13.		Pusher jumper B Put the grey jumper between the two posts on the further side.
3406.038 14.		Pusher jumper A Put the yellow jumper between the two posts on the closer side.
3622.040 15.		Stator Mark [Z] on stator.
3622.039 16.		Stator (counter 6h, 9h, chrono)
3603.079 17.		Plastic bracket Plastic bracket held by 1 screw 4000.250.
4000.250 18.		Screw
3715.094.RK 19.		Rotor







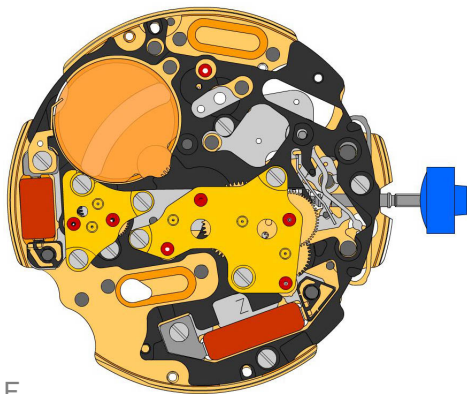

D

3147.046.CO 20.		Intermediate wheel
3136.142.CO 21.		Second wheel (long)
3122.056.CO 22.		Third wheel
2020.148.G 23.		Train wheel bridge Train wheel bridge held by 3 screws 4000.250.
4000.250 24.		Screw





E

3715.095.RK 25.		Rotor
3147.048.CO 26.		Intermediate wheel (counter)
3007.055.CO 27.		Minute wheel (counter 12h)
3402.007.CO 28.		Minute counting wheel (12h)
2020.149.G 29.		Counter train wheel bridge Counter train wheel bridge held by 3 screws 4000.250.
4000.250 30.		Screw

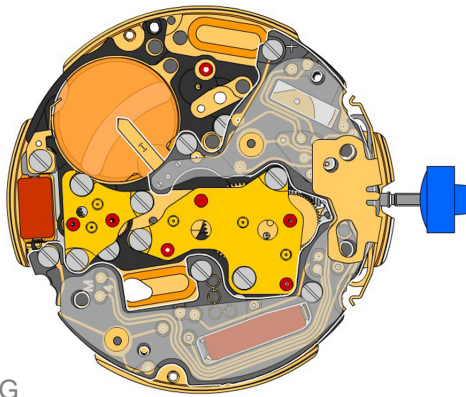



F

3621.053.RK 31.		Coil Attention: Please hold the coil only on the grey coil core. Coil held by 1 screw 4000.250.
3621.054.RK 32.		Coil (counter 9h, chrono) Attention: Please hold the coil only on the grey coil core.
3601.118 33.		Contact strip Contact strip held by 1 screw 4000.250.
4000.250 34.		Screw
3503.054 35.		Tube
3503.054 36.		Tube
3603.034 37.		Battery insulator

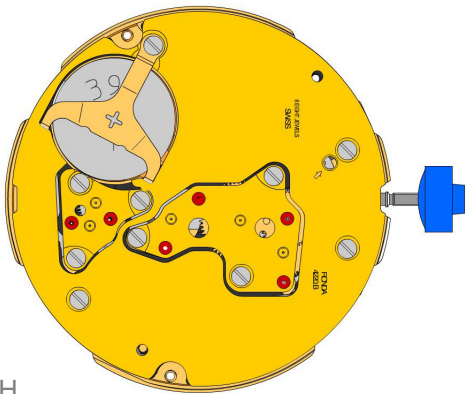







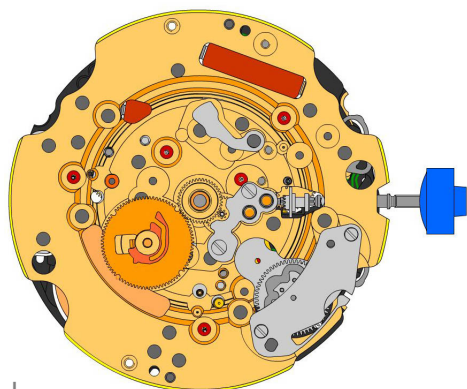
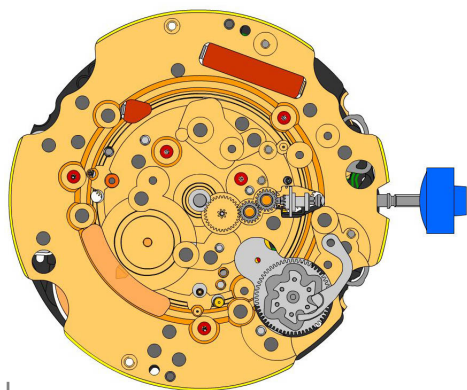





G

3612.144.4220 38.		Electronic module Electronic module held by 5 screws 4000.248. Electronic measurements may be realised now.
4000.248 39.		Screw
3603.069 40.		Circuit insulator
3601.107.G 41.		Pusher contact spring





H



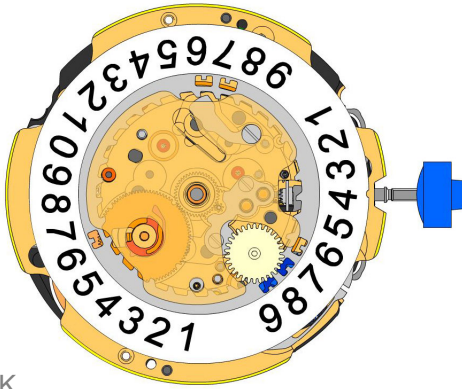
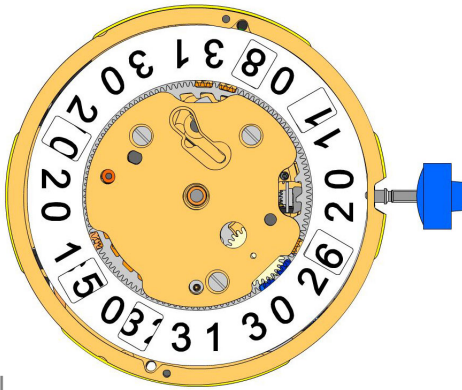

2130.138.G.M01.4220B 42.		Electronic module cover Electronic module cover held by 3 screws 4000.250.
3600.010.HGF 43.		Battery 395
3601.109.G 44.		Bridle + Bridle held by 1 screw 4000.250.
4000.250 45.		Screw







2000.574.G 46.		Main plate
3004.164 47.		Setting wheel
3004.164 48.		Setting wheel
3007.054.CO 49.		Minute wheel
2130.143 50.		Minute train bridge Minute train bridge held by 2 screws 4000.305.
4000.305 51.		Screw
3004.223 52.		Tens indicator driving wheel Parts 2030.017.CO, 3004.223 and 3500.059 must be exchanged together. The short tooth of the tens indicator driving wheel must point to the center of the movement.
3500.059 53.		Tens jumper Parts 2030.017.CO, 3004.223 and 3500.059 must be exchanged together.
2130.142 54.		Tens jumper maintaining plate Tens jumper maintaining plate held by 2 screws 4000.306. Tensioning the spring arm.
4010.306 55.		Screw
3301.242 56.		Hour wheel (Fig.2)
3315.016 57.		Friction spring
3004.224.CO 58.		Date indicator driving wheel
3500.049 59.		Date jumper

K

L

3504.214.AD.1.A 60.		Units indicator (standard) Nick of the indicator at 3 o'clock.
3147.054 61.		Tens intermediate wheel
2130.141 62.		Date indicator maintaining plate Date indicator maintaining plate held by 1 screw 4000.250.
3905.070 63.		Date jumper spring Insert the date jumper spring in the provided opening.

3504.215.AD.1.A 64.		Tens indicator (standard) Nick of the indicator at 3 o'clock
2130.140.G 65.		Date mechanism maintaining plate Date mechanism maintaining plate held by 2 screws 4000.250.
4000.250 66.		Screw
3506.072.G 67.		Dial support

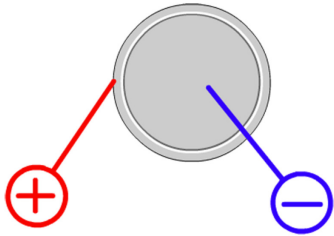
8200 68.		Moebius 8200
9014 69.		Moebius 9014
124 70.		Jismaa 124
9020 71.		Moebius 9020



Battery	395
Voltage	1.55 V

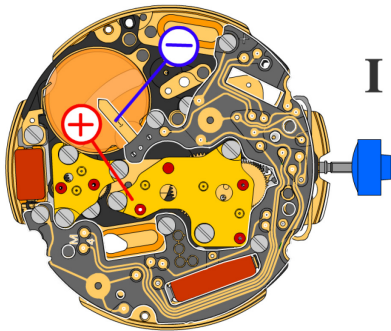

*Setting stem in position I, calendar not in gear,
60 s measuring interval for rate and consumption:*

Typical consumption	1.32 μA
Maximal consumption	1.65 μA
Rate	-10s/M. .. +20s/M.
Lower working voltage limit	1.20 V

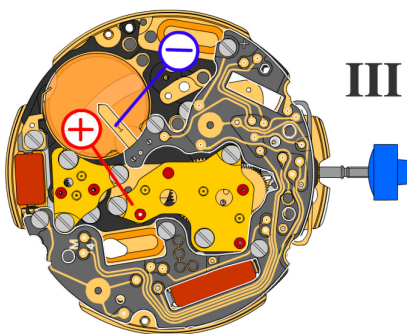

Setting stem in position III, 60 s measuring interval:

Typical consumption	0.10 μA
Maximal consumption	0.30 μA

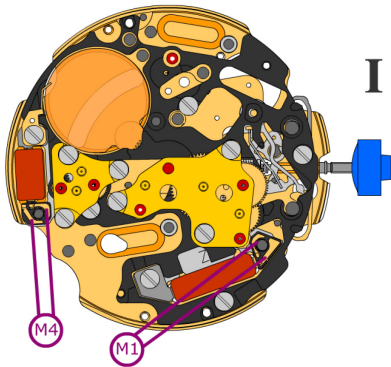

Coil resistance M1

1.90 k Ω .. 2.10 k Ω

Coil resistance M4

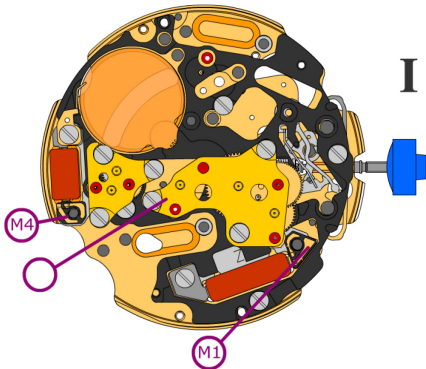
1.68 k Ω .. 1.88 k Ω

Coil isolation M1/M4

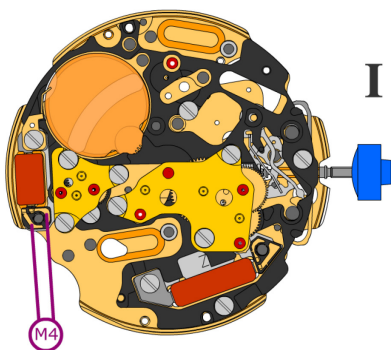
 ∞ k Ω

Signal generator (4.9 ms, 8 Hz):

Lower working voltage limit M4

1.20 V