

# RONDA startech 4000

Multifunctions with Big Date,  
Alarm, 2nd Time Zone

*Caliber 4003.B – 12½'''*



## Product Specifications

Analog quartz movement

Line startech

Caliber 4003.B

Size 12½'''

Version Swiss Made 5 Jewels / gold plated

Standard battery life 60 months

Hand fitting height 0

## Features

- Repairable metal watch movement
- Very long battery life
- Power saving mechanism with pulled out stem: Reduction of consumption approximately 70%

**Functions**

- Big date
- 3 hands

**Technical Specifications**

Diameter Total	28.60 mm
Case fitting	28.00 mm
Movement height	4.40 mm
Height over standard battery	4.40 mm
Movement rest	0.60 mm
Height over stem	1.90 mm
Length of stem travel	0.90 mm
Force to push the stem for screwed crown	10 / 15 N
Stem thread	0.90 mm
Standard battery	395
Standard battery life	60 months
Battery voltage	1.5 V
Current consumption – typical	1.19 µA (Date Mechanism not in Gear)
Current consumption – maximum	1.65 µA (Date Mechanism not in Gear)
Useful torque second – typical	6 µNm
Useful torque minute – typical	300 µNm
Operating temperature	0 - 50 °C
Instantaneous rate	-10/ +20 sec/month
Resistance to magnetic fields	18.8 Oe
Resistance against shock	NIHS 91-10



Aiguillage No.0  
 Zeigerwerkhöhe Nr.0  
 Hand height Nr.0

Important: l'aiguillage peut varier selon le modèle  
 Wichtig: die Zeigerwerkhöhe kann bei verschiedenen Modellen unterschiedlich sein  
 Important: the hand height can vary between different models

Sécurité entre l'aiguille des minutes et le verre:  
 Sicherheit zwischen Minutenzeiger und Glas: 0.30mm  
 Security between minute hand and glass:

Le cadran doit être tenu par la boîte  
 Das Zifferblatt muss durch die Schale gehalten werden  
 The dial must be hold by the case

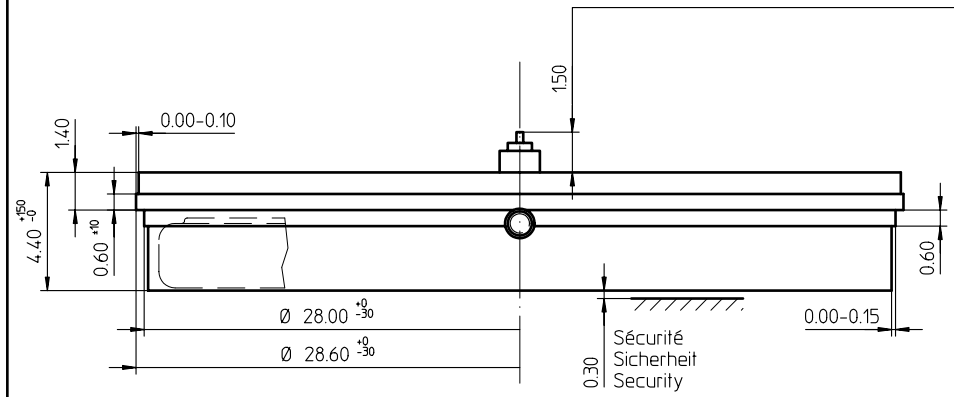

Côté fond de boîte  
 Seite Gehäuseboden  
 Case back side

Pile Batterie (395) Ø 9.50 x 2.60mm  
 Battery

Position pour extraire la tige  
 Position zum Entfernen der Stellwelle  
 Position to remove the stem

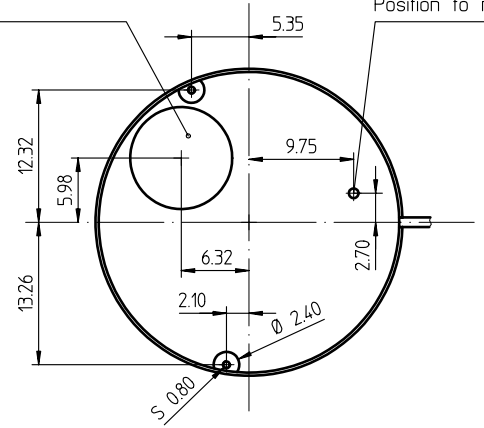

Stellwelle  
 Tige  
 Stem

Chemin:  
 Weg: 0.90  
 Way:

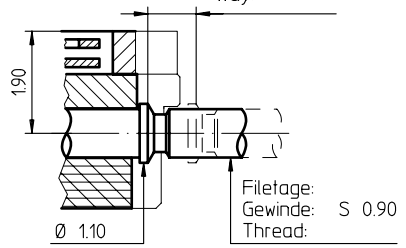

Filetage:  
 Gewinde: S 0.90  
 Thread:

Vis  
 Schraube Nr. 4000.310  
 Screw

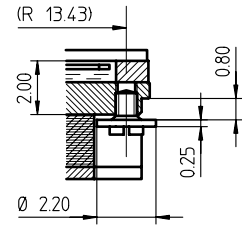

Vis  
 Schraube Nr. 4000.195  
 Screw

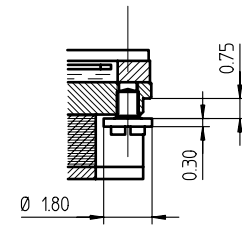

Vis  
 Schraube Nr. 4000.194  
 Screw

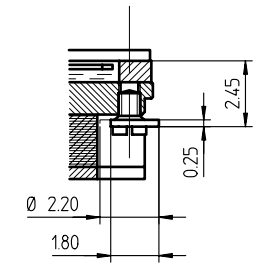

Cage Uhrwerkgestell Frame	Issued	01 Nov 2004	mk
	Modified	20.Juni 2007 AA 2180	mk
	Released	YES	
	Tolerance	+/- 20 µm	
	Scale	10 : 1 (5 : 1) (A3H)	
RONDA	4003.B	Sous réserve de modifications Aenderungen vorbehalten Modifications reserved	
		No.	5000.347





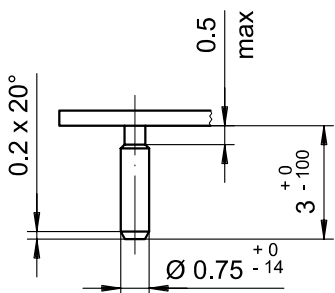
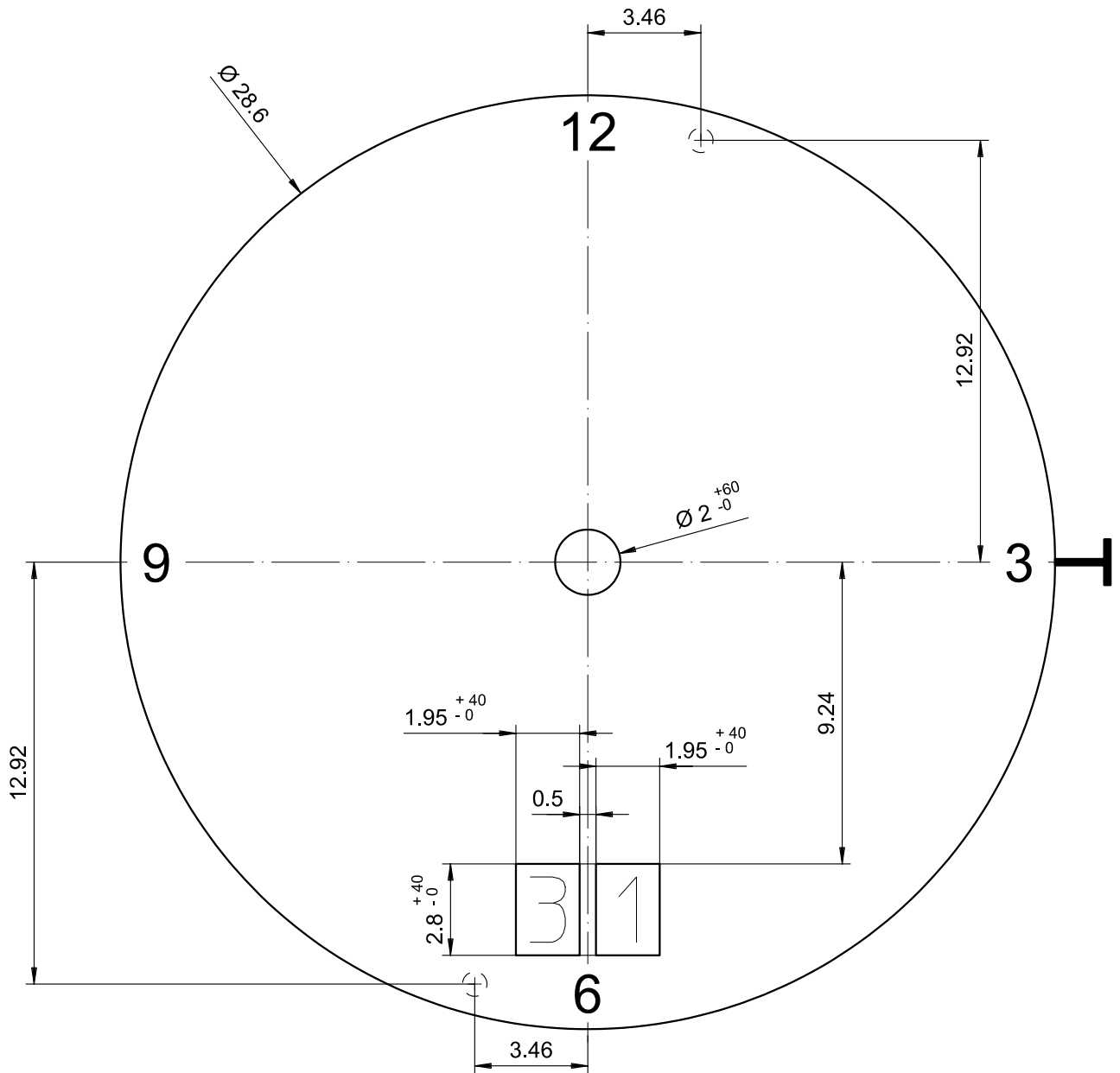

Epaisseur du cadran selon hauteur de l'aiguillage  
 Zifferblattdicke gemäss Zeigerwerkhöhen  
 Dial thickness according to hand fitting heights

Tige	Date
Stellw.	Datum
Stem	Date
3H	6H

<b>Cadran</b> <b>Zifferblatt</b> <b>Dial</b>	<b>12½"</b>	Issued	13 Dez 2006	cw
		Modified	15.Dez.2006 ÄÄ ----	cm
		Released	YES	
		Tolerance	+/- 20 µm	
		Scale	5 : 1 (A4V)	
<b>RONDA</b>	<b>4002.B, 4003.B</b>	Sous réserve de modifications Aenderungen vorbehalten Modifications reserved		
		No.	5010.702	01

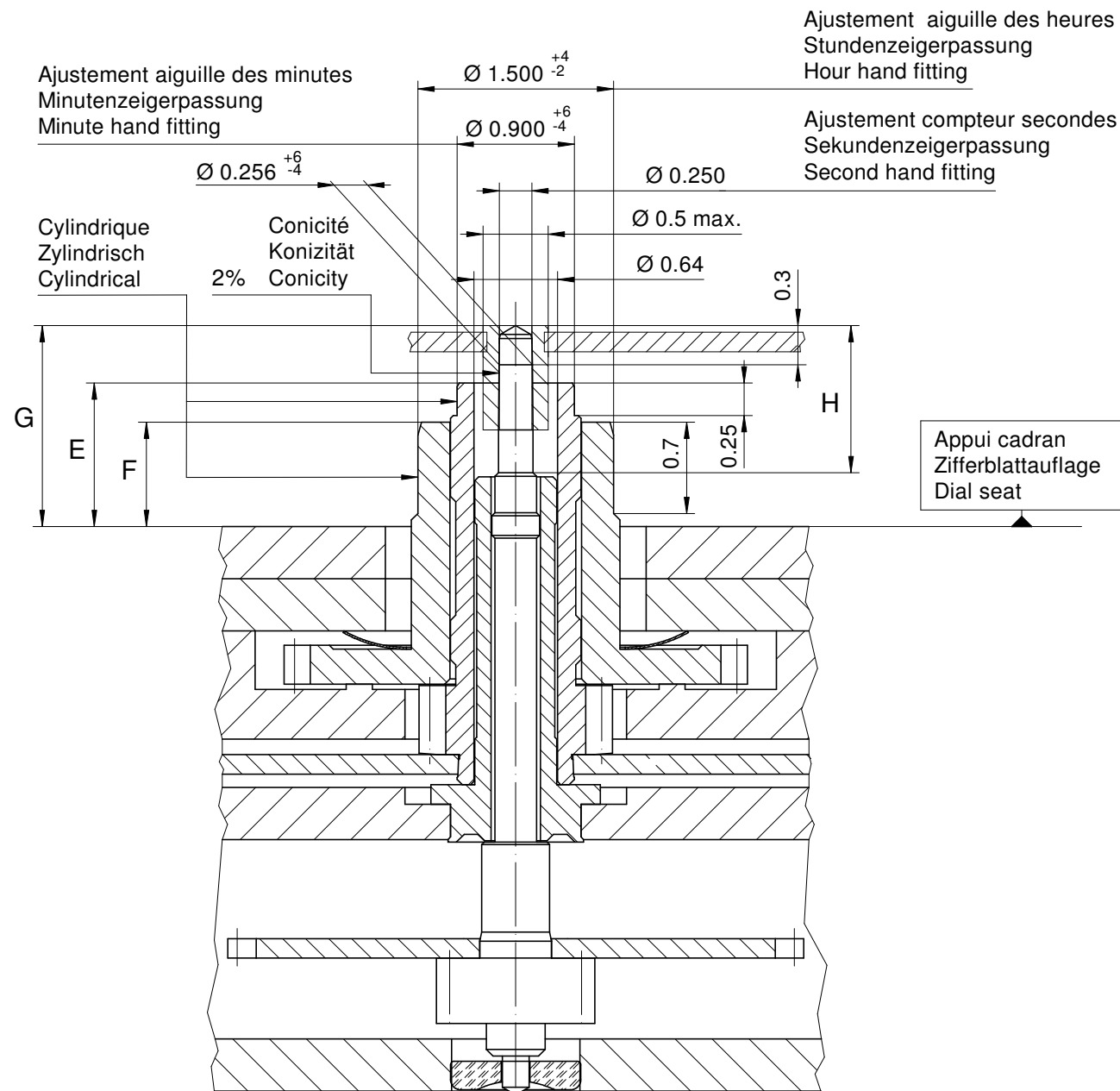

Heures / minutes / secondes  
 Stunden / Minuten / Sekunden  
 Hours / minutes / seconds

	Aig. des secondes Sekundenzeiger Second hand	Aig. des minutes Minutenzeiger Minute hand	Aig. des heures Stundenzeiger Hour hand	Lors de la pose d'aiguilles, le mouvement doit être soutenu. Beim Zeigersetzen muss das Werk abgestützt werden. The movement needs to be supported for hand setting.
mg max.	10	30	30	Masse / Masse / Weight *
µNm max.	0.07	0.80	0.80	Balourd / Unwucht / Unbalance *
gmm <sup>2</sup> max.	0.4	-	-	Inertie / Massenträgheit / Inertia *
N max.	30	40	40	Force de chassage / Aufpresskraft / Force

Aiguillages Zeigerwerkhöhe Hand fitting height				
Dépassement Höhe über Zifferblattaufgabe Height over dial seat				
No	Pignon des secondes Sekundentrieb Second pinion	Chaussée Minutenrohr Cannon-pinion	Roue des heures Stundenrad Hour wheel	
0	G	E	F	H
-	1.54	1.10	0.80	1.10

Aiguillages Zeigerwerkhöhe Hand fitting height				
Peinture comprise / inkl. Farbe / Paint included				
Epaisseur maximum du cadran Maximale Zifferblattstärke Maximum dial thickness				
No	Sous l'aiguille des secondes Unter Sekundenzeiger Under second hand	Sous l'aiguille des minutes Unter Minutenzeiger Under minute hand	Sous l'aiguille des heures Unter Stundenzeiger Under hour hand	Epaisseur des aiguilles Zeigerdicke Hands thickness
0	1.05	0.70	0.40	0.15
-				

## Aiguillages Zeigerwerkhöhen 12½" Hand fitting heights

**RONDA 4003.B**

Issued	01 Nov 2004	mk
Modified	15 Okt 2014 ÄA 13275	dh
Released	Yes	
Tolerance	µm	
Scale	20 : 1 (A3H)	
Sous réserve de modifications Änderungen vorbehalten Modifications reserved		
No.	3316.092	05

\* En cas de données différentes, veuillez contacter le service après-vente

\* Bei abweichenden Werten, bitte technischen Kundendienst anfragen

\* In case of different values, please contact the customer service

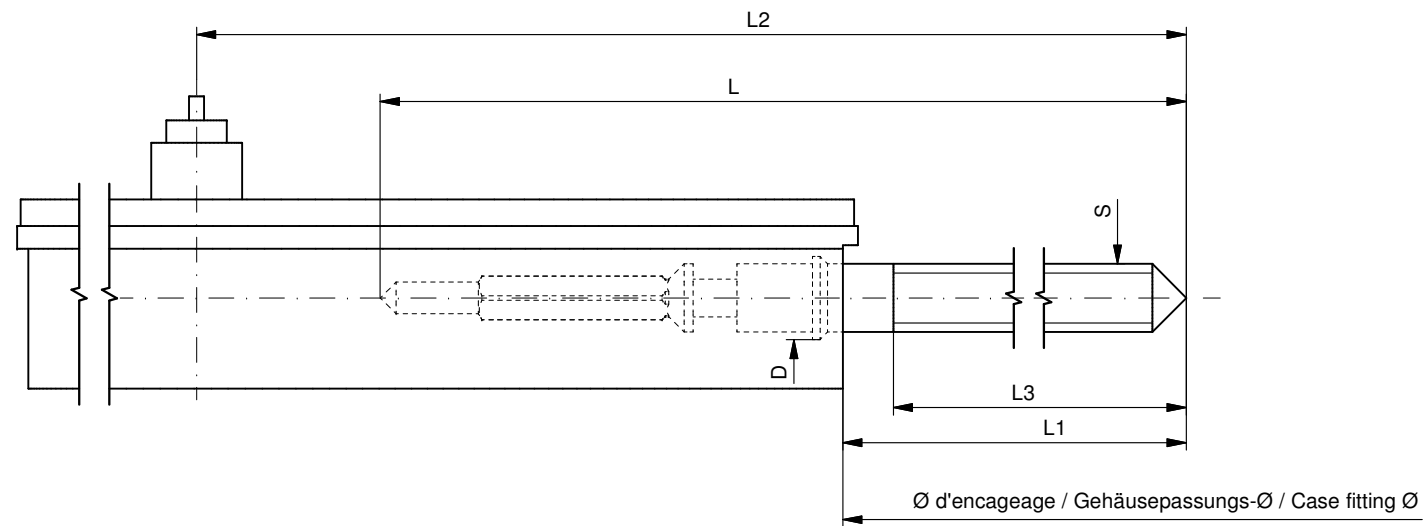

Tige de travail (intégrée dans le mouvement)  
 Arbeitstellwelle (im Werk eingebaut)  
 Working stem (implemented in the movement)

No. d'article Artikelnummer Part number	L	L1	L2	L3	S	D
3000.177.CO	20.00	10.23	24.23	10.15	0.90	1.10

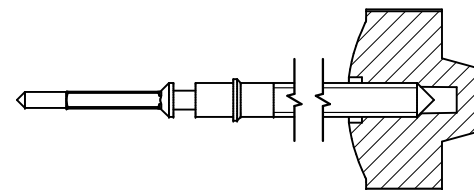

Couleur de la couronne Kronenfarbe Crown color	bleu foncé dunkelblau dark blue
Code	UN 5002

Tige (normale) / Stellwelle (normal) / Stem (normal)

No. d'article Artikelnummer Part number	L	L1	L2	L3	S	D
3000.177	20.00	10.23	24.23	10.15	0.90	1.10
3000.191	32.00	22.23	36.23	22.15	0.90	1.10

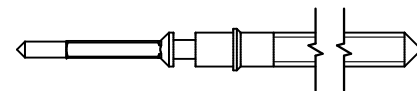

Couronne normale  
 Normale Krone  
 Normal crown

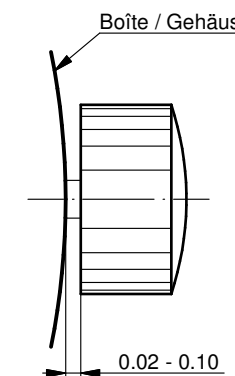

Couronne vissée  
 Geschraubte Krone  
 Screwed crown

Force ⇐ min. Kraft ⇐ min. Force ⇐ min.	10 N
Force ⇐ max. Kraft ⇐ max. Force ⇐ max.	15 N

Rallonge de tige / Stellwelle Verlängerung / Stem extension

No. d'article Artikelnummer Part number	L4	L5 (min)	L6	S1	S2	D1
3000.040	12.00	1.90	2.60	0.90	0.90	1.35

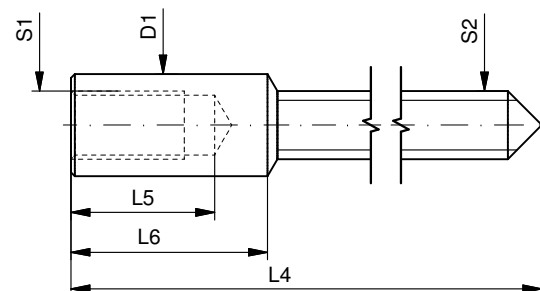

Tige (dimensions / forces)  
 Stellwelle (Dimensionen / Kräfte)  
 Stem (dimensions / forces)

RONDA

4002.B, 4003.B, 4120.B,  
 4210.B, 4220.B

Issued	05 Sep 2012	ds5222
Modified	17 Mär 2017 ÄA 34582	mg5224
Released	YES	
Tolerance	---	
Scale	10:1 (A3)	

Sous réserve de modifications  
 Änderungen vorbehalten  
 Modifications reserved

No.	5030.018	02
-----	----------	----



**Movement holder**  
*Removing setting stem*  
 H5XXX.1T



**Movement holder**  
*Setting hands*  
 H5XXX.1A

**Fitting dial and hands**

- Crown in position II
- Wind crown, until date 02 appears
- Crown in position III
- Wind hour hand forwards, until date 03 changes
- Remove working hand
- Fit dial
- Point all hands towards 12 o'clock
- Set time
- Crown in position II
- Set date
- Crown in position I

**Date switching duration:**

*First and tenth digit discs*

~2hrs

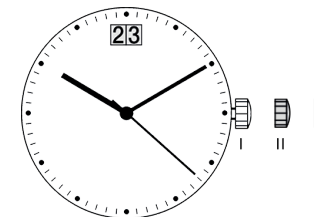
**General Instructions**

*Removing the setting stem can only be effected in Pos. I.*

*The use of supporting screws is essential when mounting the hands.*

*Permitted hand setting strengths:*

*Hr / min. hands: <40N*

*Other hand: <30N*

*During quick date correction (setting stem in position II), a date switching speed of 5 d/s must not be exceeded.*

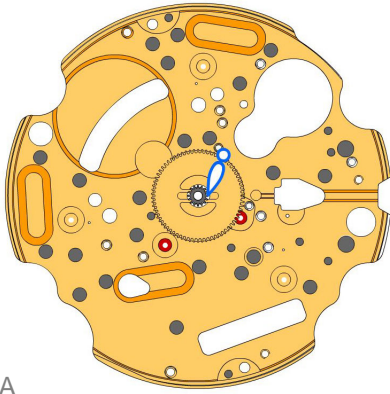



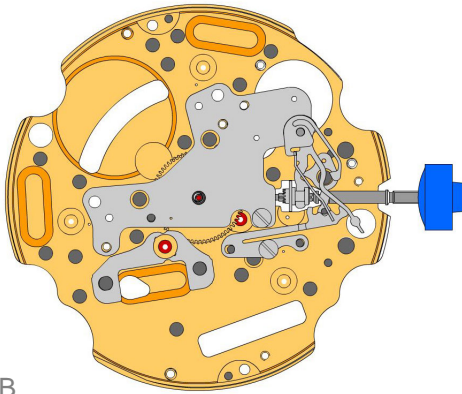



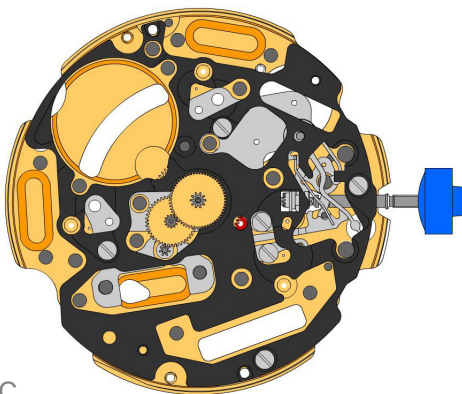

A





B

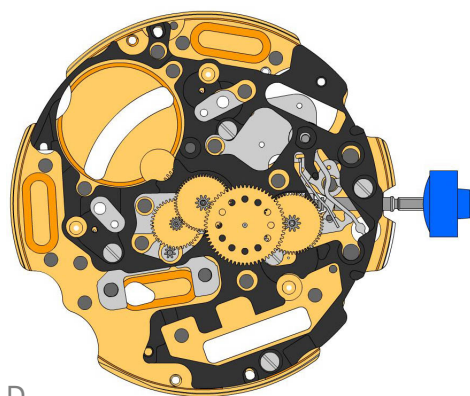

C

2000.577.G 1.		Main plate
3305.314.CO 2.		Cannon pinion with driver (Aig.0)
2030.037.CO 3.		Centre bridge Centre bridge held by 1 screw 4000.250.
4000.250 4.		Screw
3001.055.FI 5.		Sliding pinion
3000.177.CO 6.		Setting stem
3017.049 7.		Setting lever
3905.049 8.		Setting lever jumper (3 positions) Setting lever jumper held by 1 screw 4000.250.
4000.250 9.		Screw
3015.081 10.		Yoke (3 positions)
3905.067 11.		Yoke spring Tensioning the spring arm.
3622.039 12.		Stator (counter 6h, 9h, chrono)
3603.079 13.		Plastic bracket Platic bracket held by 4 screws 4000.250.
4000.250 14.		Screw
3715.094.RK 15.		Rotor
3147.047.CO 16.		Intermediate wheel (chrono)
3136.172.CO 17.		Second wheel (Aig.0)



**D**

3136.148.CO  
18.  Second wheel (short)

3122.056.CO  
19.  Third wheel

2020.164.G  
20.  Train wheel bridge  
Train wheel bridge held by 3 screws 4000.250.

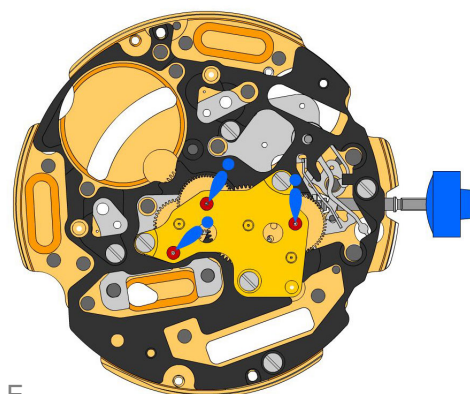
4000.250  
21.  Screw

**E**

3621.079.RK  
22.  Coil (center)  
Attention: Please hold the coil only on the grey coil core. Coil held by 1 screw 4000.250.

4000.250  
23.  Screw

3603.034  
24.  Battery insulator

3503.071  
25.  Tube



3503.059  
26.  Tube

3601.118  
27.  Contact strip  
Contact strip held by 1 screw 4000.250.

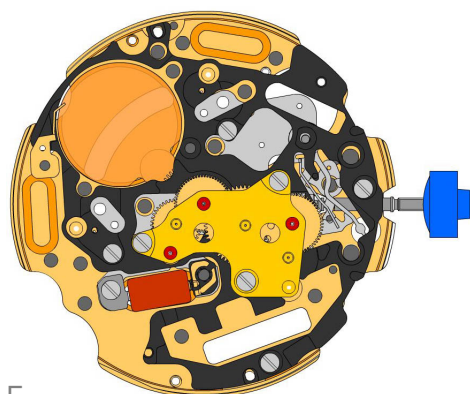

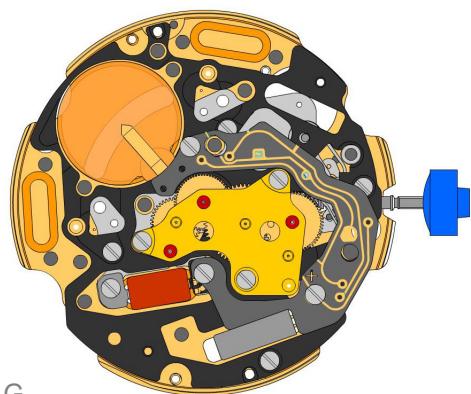

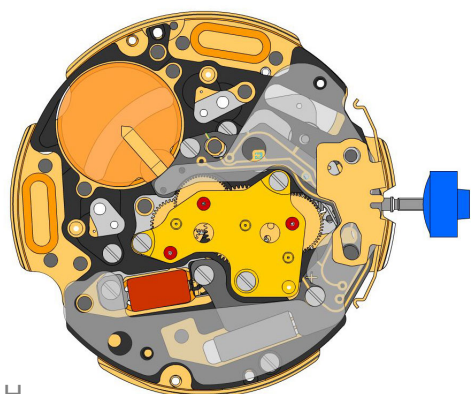

4000.250  
28.  Screw

**F**



**G**







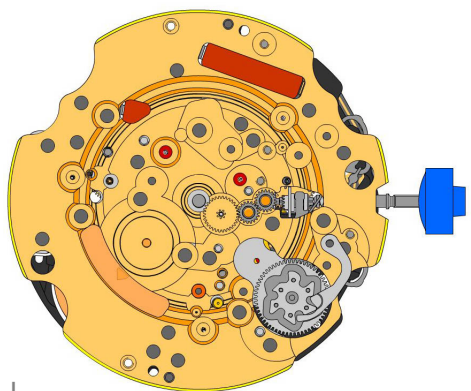
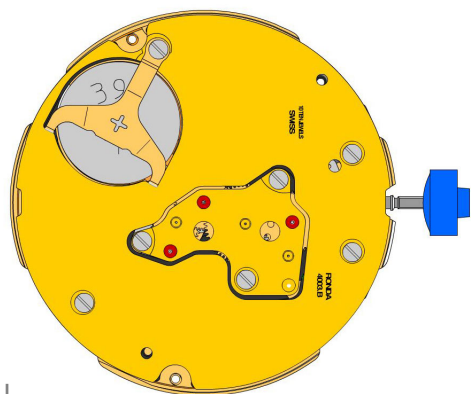







3612.147.4003 29.		<b>Electronic module</b> Electronic module held by 3 screws 4000.248. Electronic measurements may be realised now.
4000.248 30.		<b>Screw</b>
3503.068 31.		<b>Tube</b>

**H**

3603.069 32.		<b>Circuit insulator</b>
3601.107.G 33.		<b>Pusher contact spring</b>
2130.176.G.M01.4003B 34.		<b>Electronic module cover</b> Electronic module cover held by 3 screws 4000.250.
3600.010.HGF 35.		<b>Battery 395</b>
3601.109.G 36.		<b>Bridle +</b> Bridle held by 1 screw 4000.250.
4000.250 37.		<b>Screw</b>









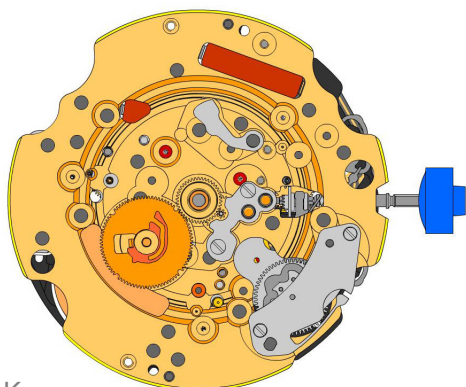





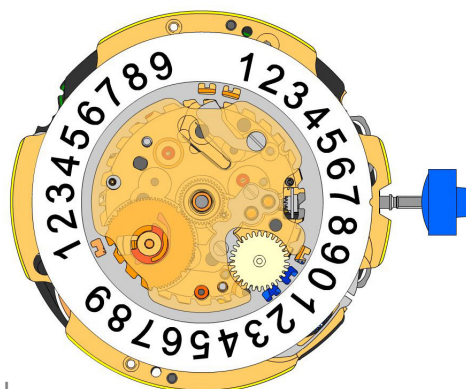

2000.577.G 38.		Main plate
3004.164 39.		Setting wheel
3004.164 40.		Setting wheel
3007.054.CO 41.		Minute wheel
2130.143 42.		Minute train bridge Minute train bridge held by 2 screws 4000.305.
4000.305 43.		Screw
3004.227 44.		Tens indicator driving wheel The short tooth of the tens indicator driving wheel must point to the center of the movement.
3500.075 45.		Tens jumper
2130.142 46.		Tens jumper maintaining plate Tens jumper maintaining plate held by 2 screws 4000.306. Tensioning the spring arm.
4010.306 47.		Screw
3301.285 48.		Hour wheel (Aig.0)
3315.016 49.		Friction spring
3004.224.CO 50.		Date indicator driving wheel
3500.049 51.		Date jumper





**K**

3504.214.AF 52.		<b>Units indicator (standard)</b> Nick of the indicator at 3 o'clock.
3147.054 53.		<b>Tens intermediate wheel</b>
2130.141 54.		<b>Date indicator maintaining plate</b> Date indicator maintaining plate held by 1 screw 4000.250.
3905.070 55.		<b>Date jumper spring</b> Insert the date jumper spring in the provided opening.

**L**

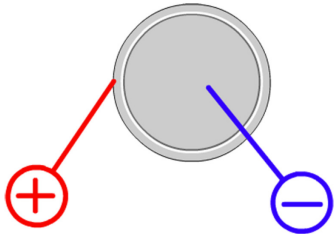
3504.216.AF 56.		<b>Tens indicator (standard)</b> Nick of the indicator at 3 o'clock.
2130.140.G 57.		<b>Date mechanism maintaining plate</b> Date mechanism maintaining plate held by 1 screw 4000.250.
4000.250 58.		<b>Screw</b>
3506.072.G 59.		<b>Dial support</b>
8200 60.		<b>Moebius 8200</b>
9014 61.		<b>Moebius 9014</b>
124 62.		<b>Jismaa 124</b>
9020 63.		<b>Moebius 9020</b>



Battery	<b>395</b>
Voltage	<b>1.55 V</b>

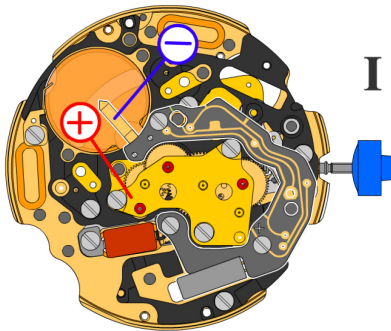

*Setting stem in position I, calendar not in gear,  
60 s measuring interval for rate and consumption:*

Typical consumption	<b>1.19 <math>\mu</math>A</b>
Maximal consumption	<b>1.65 <math>\mu</math>A</b>
Rate	<b>-10s/M. .. +20s/M.</b>
Lower working voltage limit	<b>1.20 V</b>

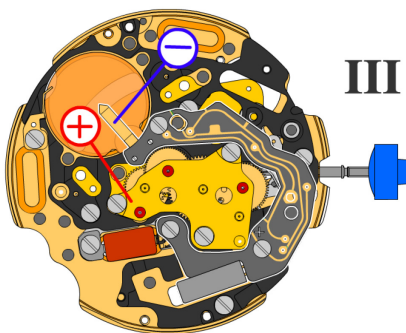

*Setting stem in position III, 60 s measuring interval:*

Typical consumption	<b>0.10 <math>\mu</math>A</b>
Maximal consumption	<b>0.30 <math>\mu</math>A</b>

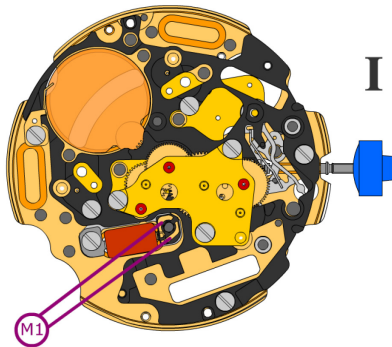

Coil resistance M1



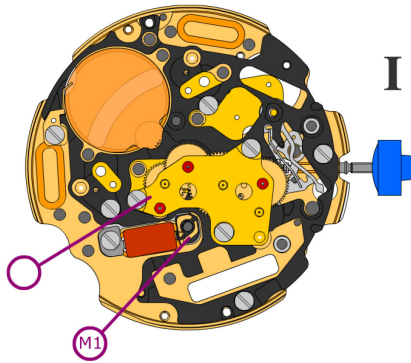



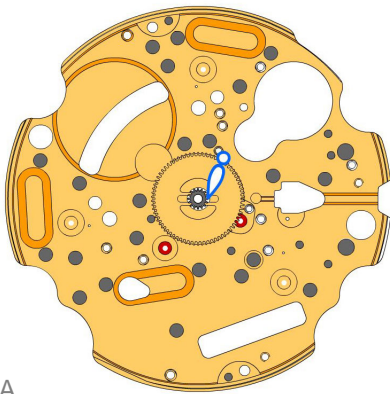
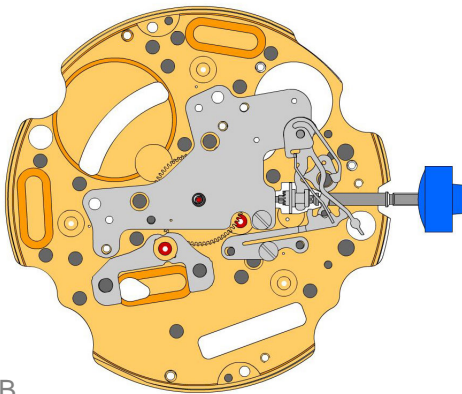
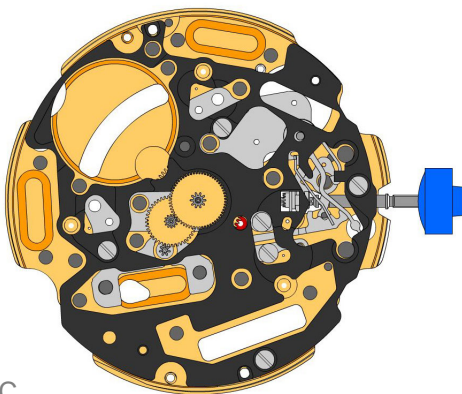

**2.20 kΩ .. 2.40 kΩ**





Coil isolation M1

**∞ kΩ**

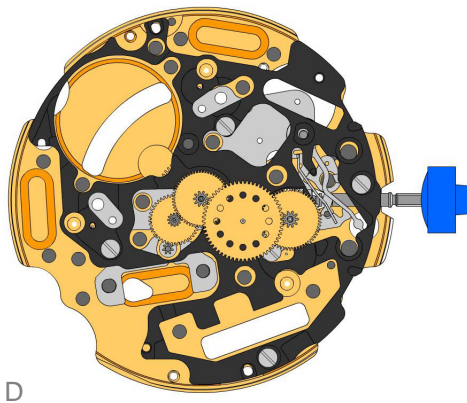

**A**

**B**

**C**

2000.577.G 1.		Main plate
3305.314.CO 2.		Cannon pinion with driver (Aig.0)
2030.017.CO 3.		Centre bridge Parts 2030.017.CO, 3004.223 and 3500.059 must be exchanged together. Centre bridge held by 1 screw 4000.250.
4000.250 4.		Screw
3001.055.FI 5.		Sliding pinion
3000.177.CO 6.		Setting stem
3017.049 7.		Setting lever
3905.049 8.		Setting lever jumper (3 positions) Setting lever jumper held by 1 screw 4000.250.
4000.250 9.		Screw
3015.081 10.		Yoke (3 positions) Parts 3015.081 and 3905.067 must be exchanged together.
3905.067 11.		Yoke spring Tensioning the spring arm. Parts 3015.081 and 3905.067 must be exchanged together.
3622.039 12.		Stator (counter 6h, 9h, chrono)
3603.079 13.		Plastic bracket Platic bracket held by 4 screws 4000.250.
4000.250 14.		Screw
3715.094.RK 15.		Rotor
3147.047.CO 16.		Intermediate wheel (chrono)
3136.172.CO 17.		Second wheel (Aig.0)



3136.148.CO  
18.  Second wheel (short)

3122.056.CO  
19.  Third wheel

2020.164.G  
20.  Train wheel bridge  
Train wheel bridge held by 3 screws 4000.250.

4000.250  
21.  Screw

D

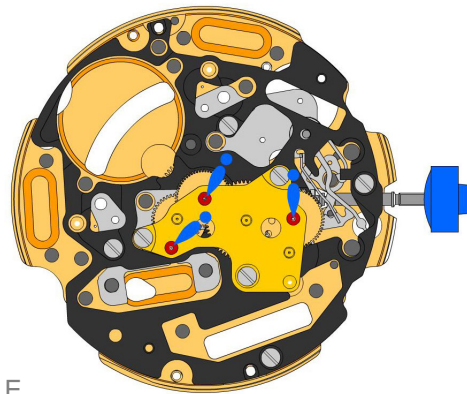

3621.079.RK  
22.  Coil (center)  
Attention: Please hold the coil only on the grey coil core. Coil held by 1 screw 4000.250.

4000.250  
23.  Screw

3603.034  
24.  Battery insulator

3503.071  
25.  Tube

3503.059  
26.  Tube

3601.118  
27.  Contact strip  
Contact strip held by 1 screw 4000.250.

4000.250  
28.  Screw

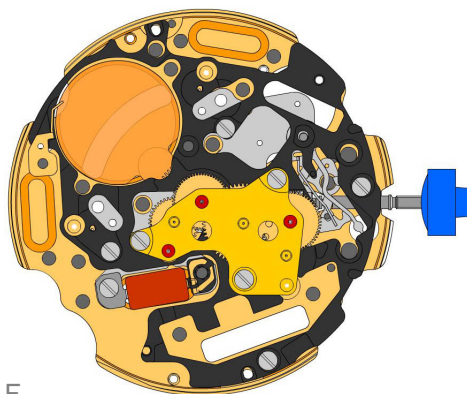

E

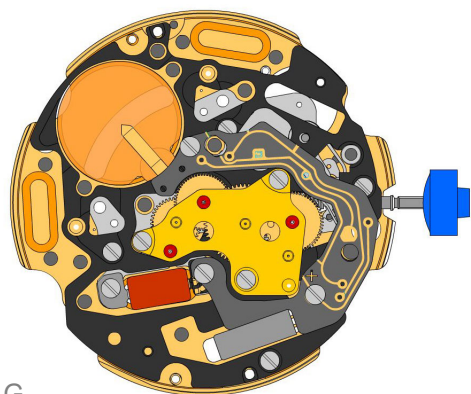

F







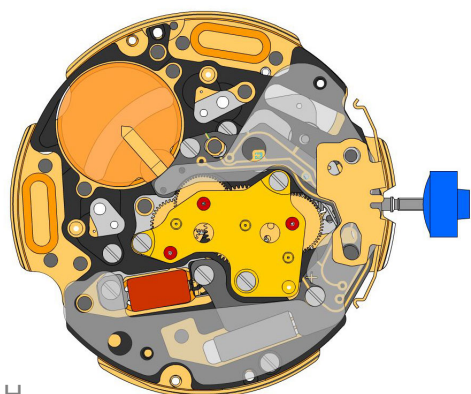

G

3612.147.4003 29.		<b>Electronic module</b> Electronic module held by 3 screws 4000.248. Electronic measurements may be realised now.
4000.248 30.		<b>Screw</b>
3503.068 31.		<b>Tube</b>









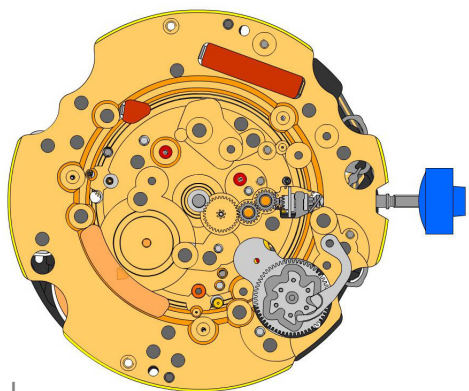
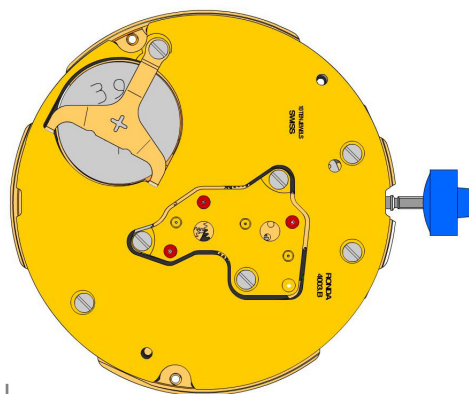







H

3603.069 32.		<b>Circuit insulator</b>
3601.107.G 33.		<b>Pusher contact spring</b>
2130.176.G.M01.4003B 34.		<b>Electronic module cover</b> Electronic module cover held by 3 screws 4000.250.
3600.010.HGF 35.		<b>Battery 395</b>
3601.109.G 36.		<b>Bridle +</b> Bridle held by 1 screw 4000.250.
4000.250 37.		<b>Screw</b>



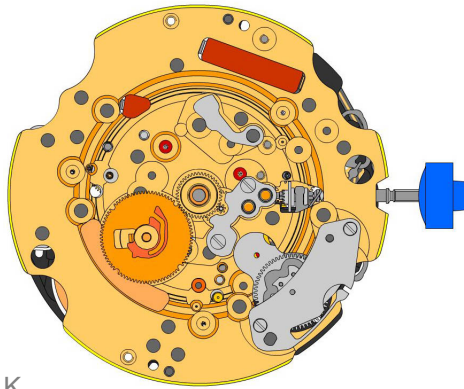

2000.577.G 38.		Main plate
3004.164 39.		Setting wheel
3004.164 40.		Setting wheel
3007.054.CO 41.		Minute wheel
2130.143 42.		Minute train bridge Minute train bridge held by 2 screws 4000.305.
4000.305 43.		Screw
3004.223 44.		Tens indicator driving wheel Parts 2030.017.CO, 3004.223 and 3500.059 must be exchanged together. The short tooth of the tens indicator driving wheel must point to the center of the movement.
3500.059 45.		Tens jumper Parts 2030.017.CO, 3004.223 and 3500.059 must be exchanged together.
2130.142 46.		Tens jumper maintaining plate Tens jumper maintaining plate held by 2 screws 4000.306. Tensioning the spring arm.
4010.306 47.		Screw
3301.285 48.		Hour wheel (Aig.0)
3315.016 49.		Friction spring
3004.224.CO 50.		Date indicator driving wheel
3500.049 51.		Date jumper

**K**
**3504.214.AF**  
52.

**Units indicator (standard)**  
Nick of the indicator at 3 o'clock.

**3147.054**  
53.

**Tens intermediate wheel**
**2130.141**  
54.

**Date indicator maintaining plate**  
Date indicator maintaining plate held by 1 screw 4000.250.

**3905.070**  
55.

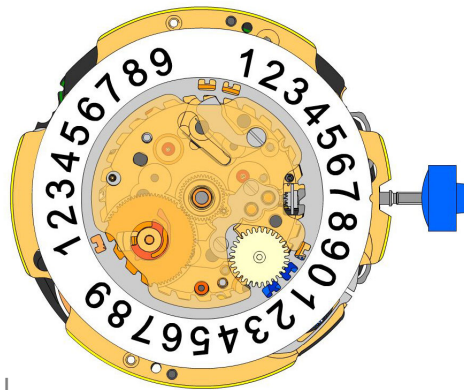
**Date jumper spring**  
Insert the date jumper spring in the provided opening.

**L**
**3504.216.AF**  
56.

**Tens indicator (standard)**  
Nick of the indicator at 3 o'clock.

**2130.140.G**  
57.

**Date mechanism maintaining plate**  
Date mechanism maintaining plate held by 1 screw 4000.250.

**4000.250**  
58.

**Screw**
**3506.072.G**  
59.

**Dial support**
**8200**  
60.

**Moebius 8200**
**9014**  
61.

**Moebius 9014**
**124**  
62.

**Jismaa 124**
**9020**  
63.

**Moebius 9020**



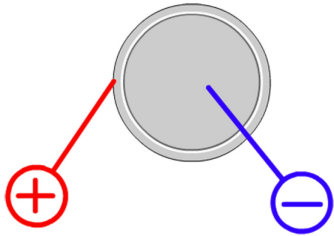

Battery	<b>395</b>
Voltage	<b>1.55 V</b>

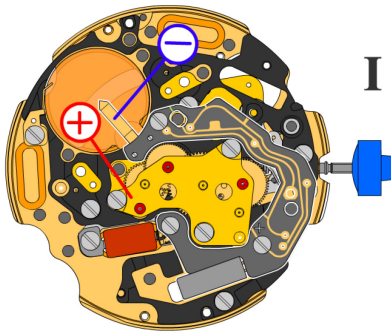

*Setting stem in position I, calendar not in gear,  
60 s measuring interval for rate and consumption:*

Typical consumption	<b>1.19 <math>\mu</math>A</b>
Maximal consumption	<b>1.65 <math>\mu</math>A</b>
Rate	<b>-10s/M. .. +20s/M.</b>
Lower working voltage limit	<b>1.20 V</b>

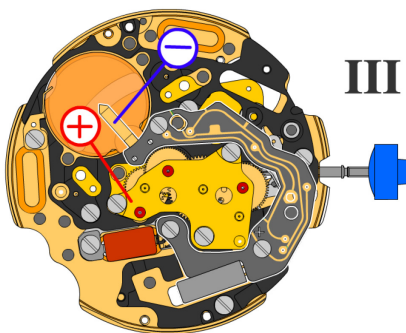

*Setting stem in position III, 60 s measuring interval:*

Typical consumption	<b>0.10 <math>\mu</math>A</b>
Maximal consumption	<b>0.30 <math>\mu</math>A</b>

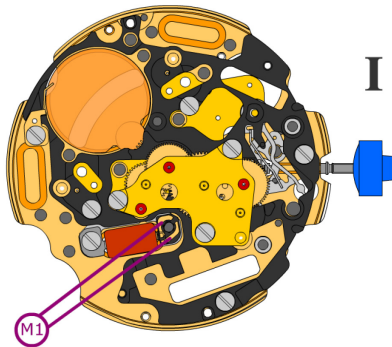

Coil resistance M1

**2.20 k $\Omega$  .. 2.40 k $\Omega$**

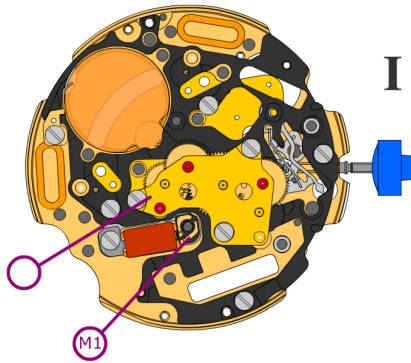

Coil isolation M1

**$\infty$  k $\Omega$**