

# RONDA powertech 500 and 762E, 763E

Affordable metal movements  
for reliable quality watches

*Caliber 519 – 11½'''*

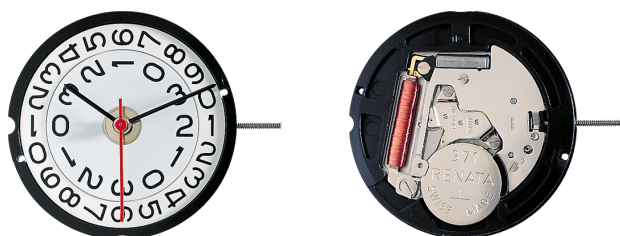

## Product Specifications

Analog quartz movement

Line		powertech
Caliber		519
Size		11½'''
Version	Swiss Made Swiss Parts	1 Jewels / nickel plated 1 Jewels / nickel plated
Standard battery life		45 months
Hand fitting height		1

## Features

- Repairable metal watch movement
- Power saving mechanism with pulled out stem: Reduction of consumption approximately 70%
- Interchangeability: All versions 11½''' with same movement height 3.00 mm and stem height 1.50 mm
- Very powerful stepping motor
- Big date with quick change

**Functions**

- Big date without direct change from 31–01
- 3 hands

**Technical Specifications**

Diameter Total	26.00 mm
Case fitting	25.60 mm
Movement height	3.00 mm
Height over standard battery	3.25 mm
Movement rest	0.80 mm
Height over stem	1.50 mm
Length of stem travel	1.00 mm
Force to push the stem for screwed crown	N
Stem thread	0.90 mm
Standard battery	371
Standard battery life	45 months
Battery voltage	1.5 V
Current consumption – typical	1.28 $\mu$ A (Date Mechanism not in Gear)
Current consumption – maximum	1.85 $\mu$ A (Date Mechanism not in Gear)
Useful torque second – typical	11 $\mu$ Nm
Useful torque minute – typical	550 $\mu$ Nm
Operating temperature	0 - 50 °C
Instantaneous rate	-10/ +20 sec/month
Resistance to magnetic fields	18.8 Oe
Resistance against shock	NIHS 91-10





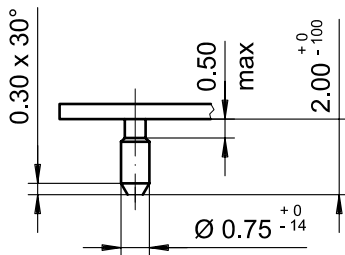
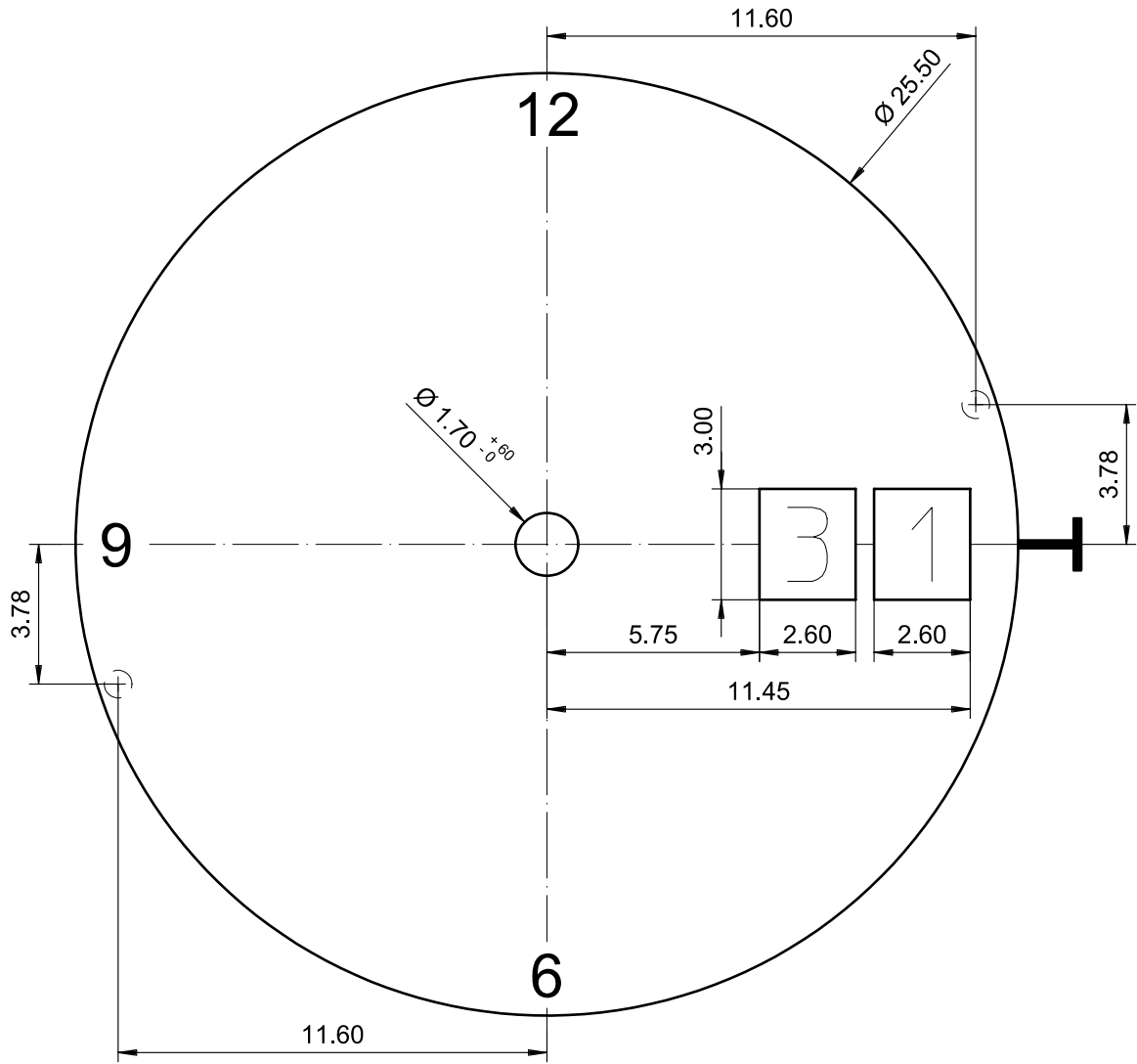

Epaisseur du cadran selon hauteur de l'aiguillage  
 Zifferblattdicke gemäss Zeigerwerkhöhen  
 Dial thickness according to hand fitting heights

Tige	Date
Stellw.	Datum
Stem	Date
<b>3H</b>	<b>3H</b>
	<input type="checkbox"/>

Cadran  
 Zifferblatt  
 Dial

11½"

Issued	14 Dez 2006	cw
Modified	15.Dez.2006 ÄA ----	cw
Released	YES	
Tolerance	+/- 20 µm	
Scale	5 : 1 (A4V)	

RONDA

519

Sous réserve de modifications  
 Aenderungen vorbehalten  
 Modifications reserved

No. 5010.492 01



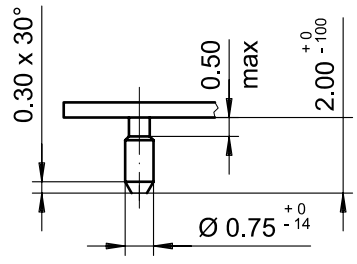
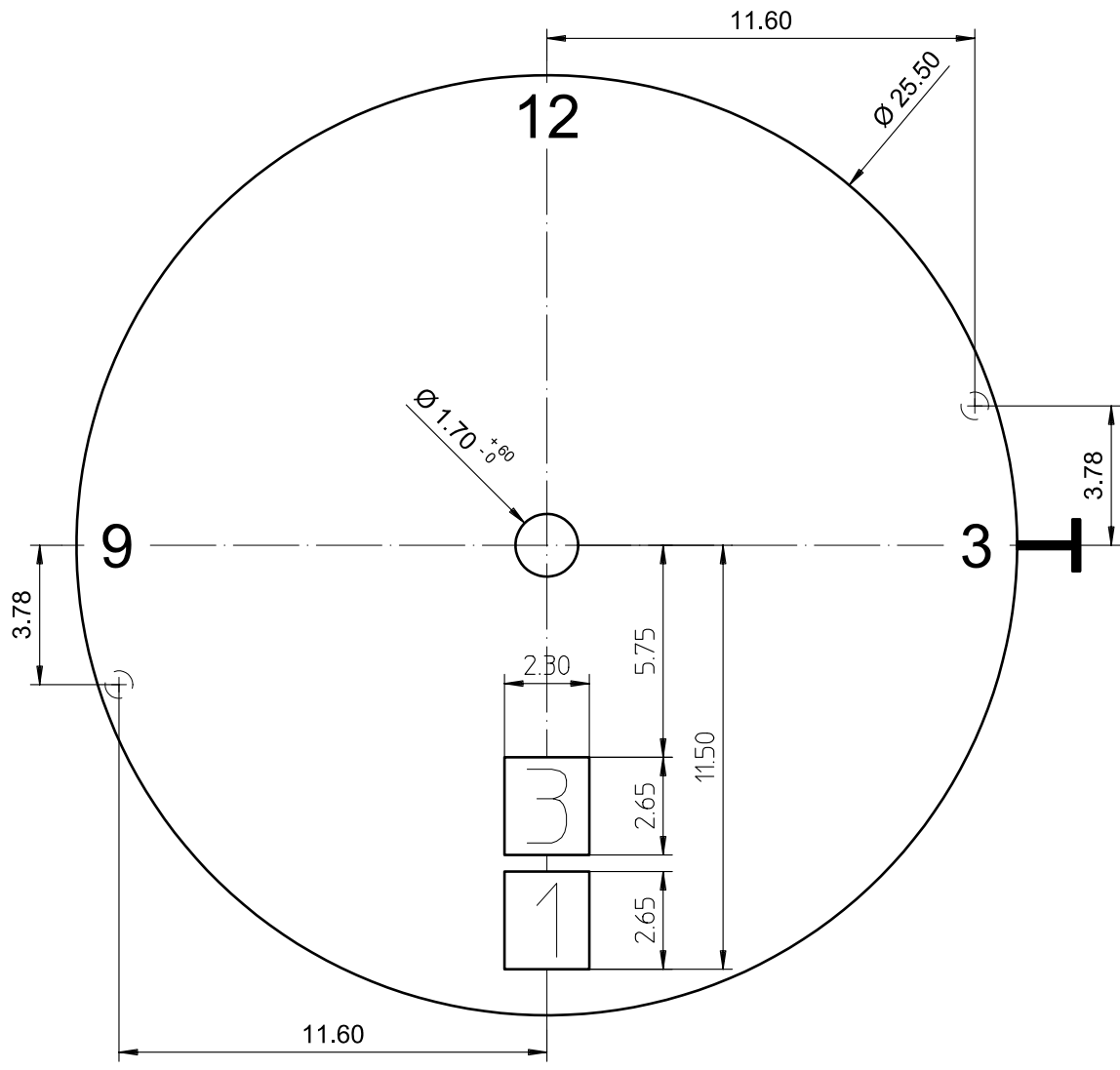

Epaisseur du cadran selon hauteur de l'aiguillage  
 Zifferblattdicke gemäss Zeigerwerkhöhen  
 Dial thickness according to hand fitting heights

Tige	Date
Stellw.	Datum
Stem	Date
<b>3H</b>	<b>6H</b>
	<input type="checkbox"/>

Cadran Zifferblatt Dial	11½"	Issued	14 Dez 2006	cw
		Modified	15.Dez.2006 ÄA ----	cw
		Released	YES	
		Tolerance	+/- 20 µm	
		Scale	5 : 1 (A4V)	
RONDA	519	Sous réserve de modifications Aenderungen vorbehalten Modifications reserved		
		No.	5010.516	01

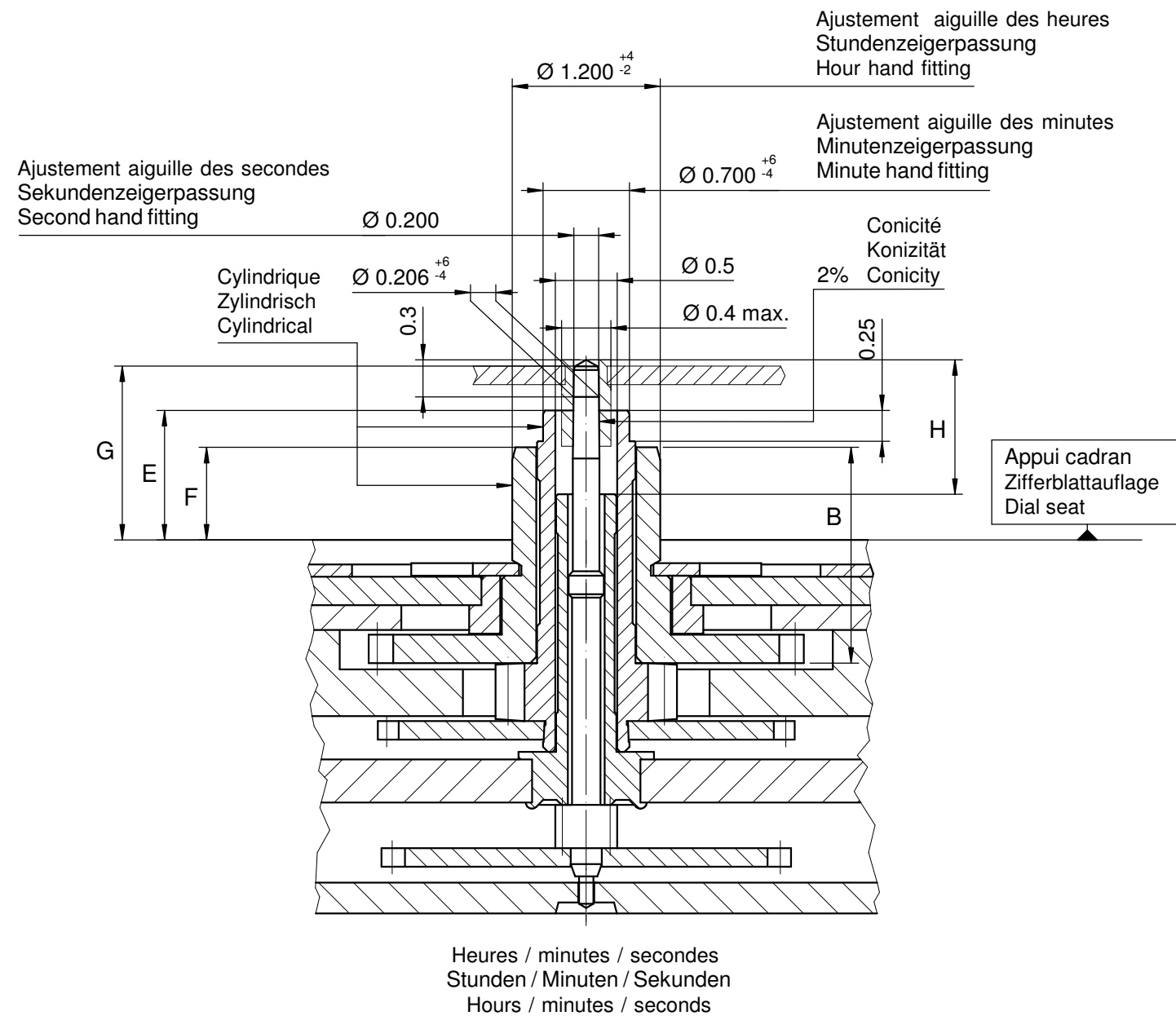

Aiguillage no Zeigerwerkhöhe Nr. Hand fitting height No	Dépassement Höhe über Zifferblattaufgabe Height over dial seat			Longueur Länge Length		Epaisseur max. (peinture comprise) Max. Dicke (inkl. Farbe) Max. thickness (paint included)			
	Pignon des secondes Sekundentrieb Second pinion	Chaussée Minutenrohr Cannon-pinion	Roue des heures Stundenrad Hour wheel			Cadran Zifferblatt Dial			Aiguilles Zeiger Hands
	G	F	F	H	B	Sous l'aiguille des secondes Unter Sekundenzeiger Under second hand	Sous l'aiguille des minutes Unter Minutenzeiger Under minute hand	Sous l'aiguille des heures Unter Stundenzeiger Under hour hand	
1	1.46	1.05	0.75	1.09	1.75	0.95	0.65	0.40	0.15
2	1.81	1.40	1.10	1.44	2.10	1.30	1.00	0.75	0.15

	Aig. des secondes Sekundenzeiger Second hand	Aig. des minutes Minutenzeiger Minute hand	Aig. des heures Stundenzeiger Hour hand	
mg max.	10	30	30	Masse / Masse / Weight *
µNm max.	0.08	0.70	0.70	Balourd / Unwucht / Unbalance *
gmm <sup>2</sup> max.	0.4	-	-	Inertie / Massenträgheit / Inertia *
N max.	30	40	40	Force de chassage / Aufpresskraft / Force

Lors de la pose d'aiguilles, le mouvement doit être soutenu.  
Beim Zeigersetzen muss das Werk abgestützt werden.  
The movement needs to be supported for hand setting.

Sous réserve de toutes modifications

Aenderungen vorbehalten

All modifications reserved

**Aiguillages**  
**Zeigerwerkhöhen**  
**Hand fitting heights**

10<sup>1</sup>/<sub>2</sub>" , 11<sup>1</sup>/<sub>2</sub>"

**RONDA**

**507, 509, 517, 519**  
**505.24D, 515.24D**

Issued	10 Mär 1999	gd
Modified	20 Apr 2011 ÄA 10340	ps
Released	Yes	
Tolerance	µm	
Scale	20 : 1 (A3H)	
Sous réserve de modifications Aenderungen vorbehalten Modifications reserved		
No.	3316.060	06

Ajustement aiguille des secondes  
Sekundenzeigerpassung  
Second hand fitting

Ajustement aiguille des heures  
Stundenzeigerpassung  
Hour hand fitting

Ajustement aiguille des minutes  
Minutenzeigerpassung  
Minute hand fitting

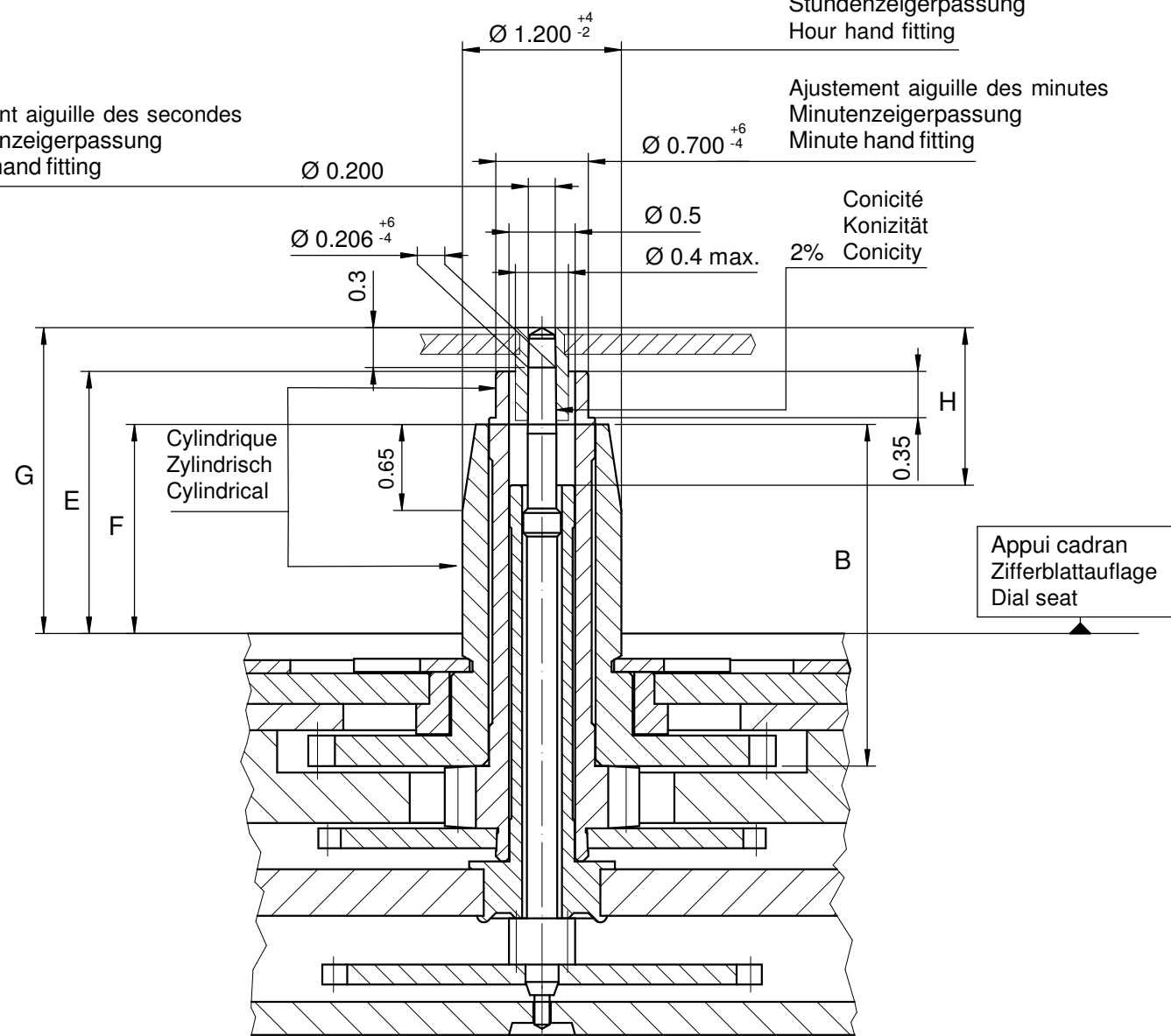

Heures / minutes / secondes  
Stunden / Minuten / Sekunden  
Hours / minutes / seconds

Aiguillage no ZeigerwerkhöheNr. Hand fitting height No	Dépassement Höhe über Zifferblattaufgabe Height over dial seat			Longueur Länge Length		Epaisseur max. (peinture comprise) Max. Dicke (inkl. Farbe) Max. thickness (paint included)			
	Pignon des secondes Sekundentrieb Second pinion	Chaussée Minutenrohr Cannon-pinion	Roue des heures Stundenrad Hour wheel		Roue des heures Stundenrad Hour wheel	Cadran Zifferblatt Dial			Aiguilles Zeiger Hands
	G	E	F	H	B	Sous l'aiguille des secondes Unter Sekundenzeiger Under second hand	Sous l'aiguille des minutes Unter Minutenzeiger Under minute hand	Sous l'aiguille des heures Unter Stundenzeiger Under hour hand	
6	2.31	1.98	1.58	1.19	2.58	1.80	1.55	0.40	0.15

	Aig. des secondes Sekundenzeiger Second hand	Aig. des minutes Minutenzeiger Minute hand	Aig. des heures Stundenzeiger Hour hand	Lors de la pose d'aiguilles, le mouvement doit être soutenu. Beim Zeigersetzen muss das Werk abgestützt werden. The movement needs to be supported for hand setting.
mg max.	10	30	30	Masse / Masse / Weight *
µNm max.	0.08	0.70	0.70	Balourd / Unwucht / Unbalance *
gmm <sup>2</sup> max.	0.4	-	-	Inertie / Massenträgheit / Inertia *
N max.	30	40	40	Force de chassage / Aufpresskraft / Force

Sous réserve de toutes modifications

Aenderungen vorbehalten

All modifications reserved

<b>Aiguillages</b> <b>Zeigerwerkhöhen</b> <b>Hand fitting heights</b>	Issued	23 Mai 2011	dh
	Modified	24 Mai 2011 ÄA 11034	dh
	Released	Yes	
	Tolerance	µm	
	Scale	20 : 1 (A3H)	
<b>RONDA</b> <b>507, 509, 517, 519</b> <b>505.24D, 515.24D</b>	Sous réserve de modifications Aenderungen vorbehalten Modifications reserved		
	No.	3316.157	00

\* En cas de données différentes, veuillez contacter le service après-vente

\* Bei abweichenden Werten, bitte technischen Kundendienst anfragen

\* In case of different values, please contact the customer service

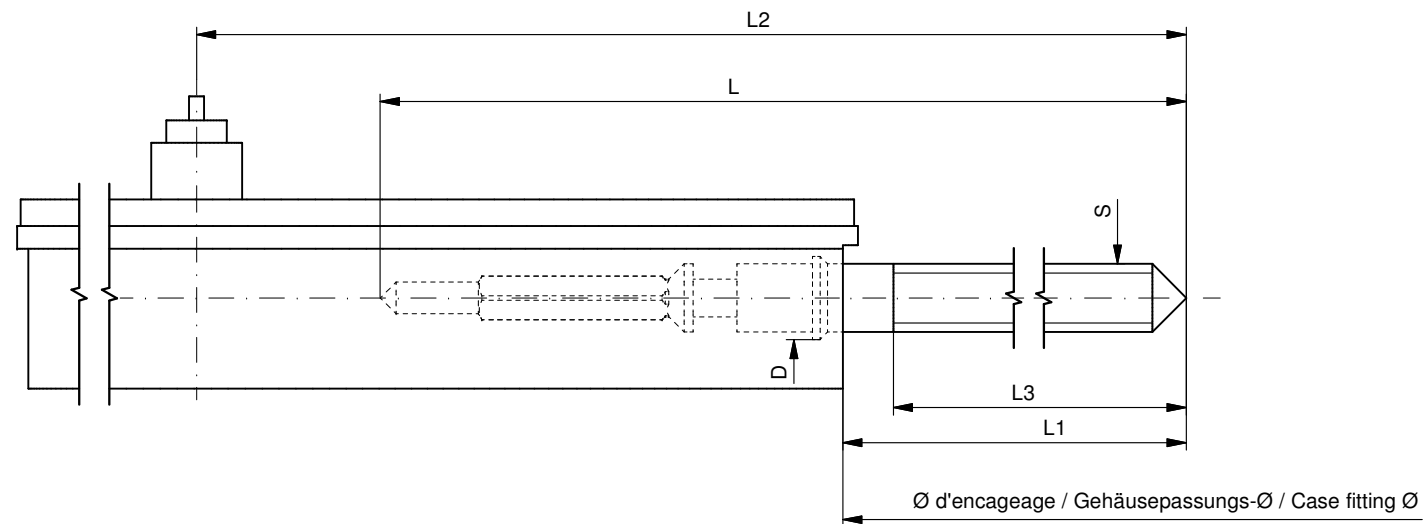

Tige de travail (intégrée dans le mouvement)  
 Arbeitstellwelle (im Werk eingebaut)  
 Working stem (implemented in the movement)

No. d'article Artikelnummer Part number	L	L1	L2	L3	S	D
3000.164.CO	20.50	9.92	22.72	11.83	0.90	1.05

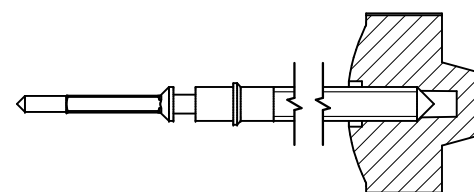

Couleur de la couronne Kronenfarbe Crown color	brun braun brown
Code	UN 8052

Tige (normale) / Stellwelle (normal) / Stem (normal)

No. d'article Artikelnummer Part number	L	L1	L2	L3	S	D
3000.164	20.50	9.92	22.72	11.83	0.90	1.05
3000.171	32.50	21.92	34.72	23.83	0.90	1.05

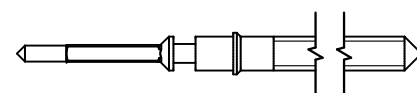

Couronne normale  
 Normale Krone  
 Normal crown

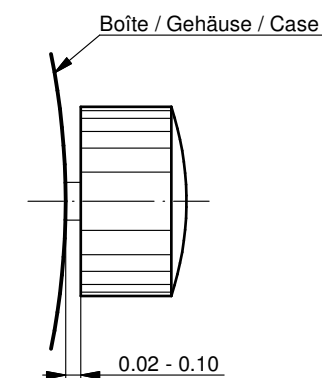

Couronne vissée  
 Geschraubte Krone  
 Screwed crown

Force ⇐ min. Kraft ⇐ min. Force ⇐ min.	10 N
Force ⇐ max. Kraft ⇐ max. Force ⇐ max.	15 N

Tige (à arracher)  
 Stellwelle (Ausreissversion)  
 Stem (extractable version)

No. d'article Artikelnummer Part number	L	L1	L2	L3	S	D
3000.163	20.05	9.92	22.72	11.83	0.90	1.05
3000.196	32.50	21.92	34.72	23.83	0.90	1.05

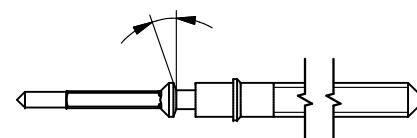

Rallonge de tige / Stellwelle Verlängerung / Stem extension

No. d'article Artikelnummer Part number	L4	L5 (min)	L6	S1	S2	D1
3000.040	12.00	1.90	2.60	0.90	0.90	1.35

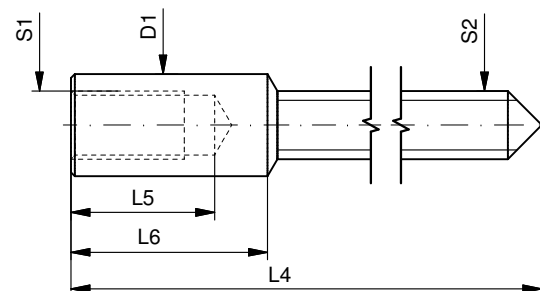

Tige (dimensions / forces)  
 Stellwelle (Dimensionen / Kräfte)  
 Stem (dimensions / forces)

RONDA

512, 513, 513S, 515, 515S,  
 515.24H, 515.24D, 517, 519

Issued	15 Aug 2012	ds5222
Modified	17 Mär 2017 ÄA 34582	mg5224
Released	YES	
Tolerance	---	
Scale	10:1 (A3)	

Sous réserve de modifications  
 Änderungen vorbehalten  
 Modifications reserved

No.	5030.002	01
-----	----------	----

## User's Manual English Movements Caliber

### RONDA powertech

- 505.24D/515.24D
- 505.24H/515.24H
- 507/517
- 509/519

You have decided to buy a watch, which was assembled by a watchmaker using a Ronda movement. Please note that no watches are produced or distributed under the Ronda brand.

In case of repairs, guarantee claims and questions concerning the functioning of a watch, purchasers and consumers should contact their retailer or the watch manufacturer, for which the relevant information can be found in the sales or guarantee documentation provided with the watch.



Cal. 505.24D / 515.24D



Cal. 505.24H / 515.24H

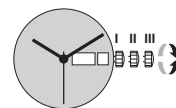

Cal. 507 / 517

**Pos. I Position of rest** (watch running)

**Pos. II Quick-change correction for date**

*The date can also be corrected during the day-changing phase between 10 pm and midnight. The date of the following day has to be set, because no automatic date change takes place at midnight.*

- Pull the crown out to position II (watch still running).
- Turn the crown clockwise until the required date appears.
- Push the crown back into position I.

**Quick-change correction for 24-hour display**

- Pull the crown out to position II (watch still running).
- Turn the crown anticlockwise until the desired time appears.
- Push the crown back into position I.

**Pos. III Setting the time**

- Pull the crown out to position III (watch stopped).
- Turn the crown, until the current time is displayed (remember the 24-hour cycle).
- Push the crown back into position I.

**Pos. I Position of rest** (watch running)

**Pos. II Quick-change correction for date**

*The date can also be corrected during the day-changing phase between 10 pm and midnight. The date of the following day has to be set, because no automatic date change takes place at midnight.*

- Pull the crown out to position II (watch still running).
- Turn the crown until the required date appears.
- Push the crown back into position I.

**Quick-change correction for day of the week**

*The blocking time for the day of the week quick-change correction is from approx. 10 pm and midnight.*

- The second language always first appears around 24.00hrs for about 2 hours, until the display changes to the required language.
- Pull the crown out to position II (watch still running).
- Turn crown anticlockwise until the desired day of the week appears in the required language.
- Push the crown back into position.



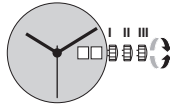

#### Cal. 507/517

##### Pos. III Setting the time

- Pull the crown out to position III (watch stopped).
- Turn the crown, until the current time is displayed (remember the 24-hour cycle).
- Push the crown back into position I.

#### Cal. 509/519

##### Pos. I Position of rest (watch running)

##### Pos. II Quick-change correction for date

*The date display comprises a 2-disc system. For construction reasons, on the first day of a new month, the date must be set on 01 via the quick-change method passing through 31-39.*

*The date can also be changed during the day-changing phase between approx. 10 pm and midnight. The date of the following day has to be set, because no automatic date change takes place at midnight.*

- Pull the crown out to position II (watch still running).
- Turn the crown clockwise until the required date appears.
- Push the crown back into position I.

##### Pos. III Setting the time

- Pull the crown out to position III (watch stopped).
- Turn the crown, until the current time is displayed (remember the 24-hour cycle).
- Push the crown back into position I.

##### Applies to all calibers:

Battery type: 371/SR920SW

Precision: +20/-10 seconds per month





11 1/2<sup>mm</sup>

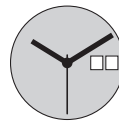

519

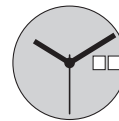

519S

**Funktionen**

**Fonctions**

**Functions**

Kaliber	Stellwellenpos.	Funktionen
Calibre	Pos. de tige	Fonctions
Caliber	Stem position	Functions
519	1	Normale Position / Position normale / Running position
	2	Datumkorrektur / Correction de la date / Date correction
	3	Zeiger stellen, Sekunden-Stopp mit Unterbruch der Motorimpulse Mise à l'heure, stop-seconde avec interruption des impulsions moteur Hand setting, stop-second with interruption of motor pulses

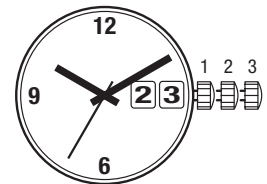

**Batterie**

**Pile**

**Battery**

Kaliber	Batterie	Spannung	Artikelnummer RONDA
Calibre	Pile	Voltage	Numero d'article RONDA
Caliber	Battery	Tension	Part number RONDA
519	371/SR920SW	1.55 V	3600.015.HGF

11 1/2''' 519, 519S

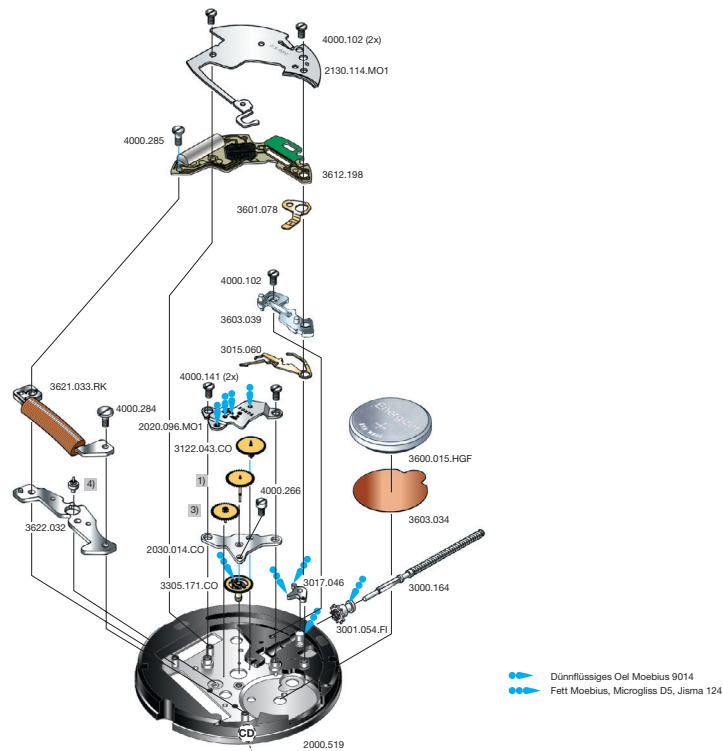

Plan No.	Bestandteile	Fournitures	Spare Parts
2000.519	Werkplatte	Platine	Main plate
2020.096.MO1	Räderwerkbrücke	Pont rouage	Train w. bridge
2030.014.CO	Zentrumbrücke	Pont centre	Centre bridge
2130.114.MO1	Modul-Abdeckp.	Couvre module	Module cover pl.
3000.164	Stellwelle	Tige	Stem
3001.054.FI	Kupplungstrieb	Pignon coulant	Sliding pinion
3015.060	Kuppl.-triebhebel	Bascule	Yoke
3017.046	Winkelhebel	Tirette	Setting lever
3122.043.CO	Kleinbodenrad	Roue moyenne	Third wheel
1)	Sekundenrad	Roue secondes	Second-wheel
3)	Zwischenrad	Roue interméd.	Intermed. wheel
3305.171.CO	Minutenrohr	Chaussée	Cannon pinion
3600.015.HGF	Batterie	Pile	Battery
3601.078	Batterie-Kontakt	Bride contact	Battery contact
3603.034	Batterie-Isolation	Isolateur pile	Battery insulation
3603.039	Deckplatte/ Ste.	Couvre mécan.	Setting lev. cover
3612.198	Modul	Module	Module
3621.033.RK	Spule	Bobine	Coil
3622.032	Stator	Stator	Stator
4)	Rotor	Rotor	Rotor
4000.102	Schraube	Vis	Screw
4000.141	Schraube	Vis	Screw
4000.266	Schraube	Vis	Screw
4000.284	Schraube	Vis	Screw
4000.285	Schraube	Vis	Screw

Code: Beispiel CD / exemple CD / exemple CD

Cal.519		
	Bis Juni 2015 Jusqu' en Juin 2015 Until June 2015	Ab Juli 2015 A partir de Juillet 2015 From July 2015
Code	2. Buchstabe ... <b>C</b> Second letter ... <b>C</b> 2 <sup>ème</sup> chiffre: ... <b>C</b>	2. Buchstabe: ab <b>D</b> Second letter: from <b>D</b> 2 <sup>ème</sup> chiffre: à partir de <b>D</b>
1)	3136.090.CO	3136.194.CO
3)	3147.019.CO	3147.092.CO
4)	3715.089.RK	3715.144.RK

Die obigen 3 Teile bilden jeweils eine Gruppe. Deshalb sind die 3 Teile jeder Gruppe nicht einzeln gegeneinander austauschbar.

Les 3 fournitures ci-dessous forment un groupe individuel. C'est pourquoi les 3 fournitures de chaque groupe ne sont pas interchangeables.

The 3 parts mentioned above are forming an individual group. Therefore the 3 parts of each group are not interchangeable.

Abweichungen / Divergences / Deviations

Plan No.	Bestandteile	Fournitures	Spare Parts
3612.199	Modul	Module	Module
3621.036.RK	Spule	Bobine	Coil

11 1/2''' 519, 519S

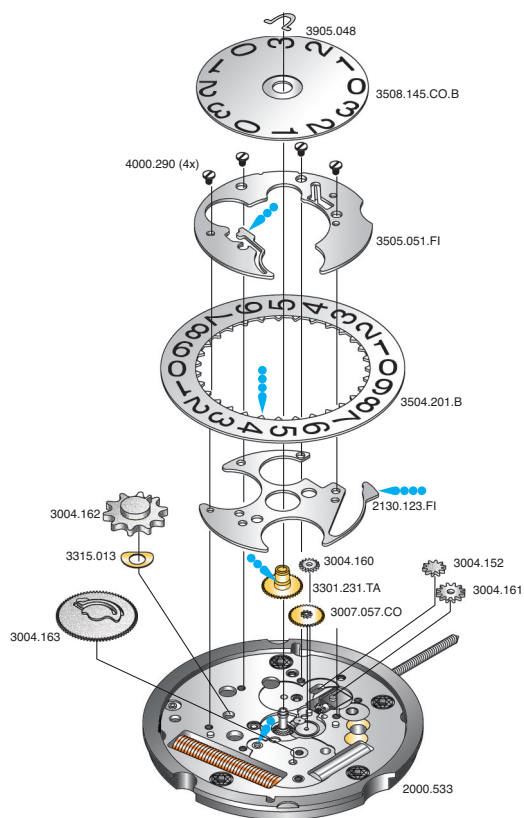

- Dünnflüssiges Öl Moebius 9014
- Moebius 9020
- Fett Moebius, Microgliss 1 4

Cal. 519 Zifferblattseite / Côté cadran / Dial side			
Plan No.	Bestandteile	Fournitures	Spare Parts
2130.123.FI	Kalenderplatte	Plaque calendrier	Date indicator pl.
3004.152	Umkehrad	Baladeur	Sliding gear
3004.160	Zeigerstellrad	Renvoi minuterie	setting wheel
3004.161	Verbindungsrad- Kupplungtrieb	Renvoi pig. cou.	Sliding pin. set.
3004.162	Verbindungsrad Kal.-Ring	Renvoi baque	Sl. wheel dt. ind.
3004.163	Dat.-Mitn.rad	Renvoi entraîneur	Ind. driving wh.
3007.057.CO	Wechselrad	Minuterie	Minute wheel
3301.231.TA	Stundenrad	Canon	Hour wheel
3315.013	Spreizfeder 3°	Clinquant 3°	Washer 3°
3504.201.B	Datumanzeiger	Baque	Date indicator
3505.051.FI	Kal.-Abdeckplatte	Couvercle calend.	Date ind. cover
3508.145.CO.B	Datumscheibe	Disque	Disc
3905.048	Klemmfeder für Tagesscheibe	Clavett disque	Disc spring clip
4000.290	Schraube	Vis	Screw

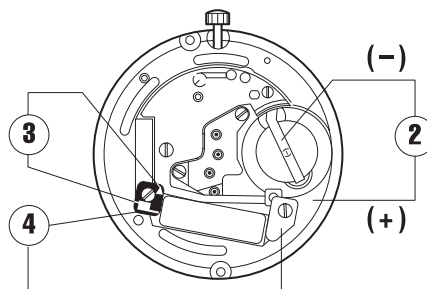
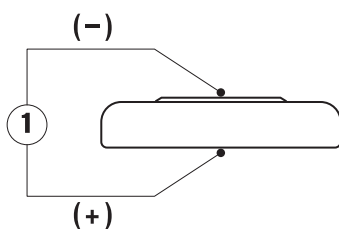

Kaliber Calibre Caliber	Pos. Pos. Pos.	Einheit Unité Unit	Messwerte Valeurs mesurées Measured values	Kontrolle Contrôle Check	Bemerkungen Remarques Remarks
519, 519S	1	V	1,55	Batterie-Spannung Tension de la pile Battery voltage	Batterie herausnehmen und messen Enlever et mesurer la pile Remove battery for measuring
519 519S	2	µA	1,10–1,85 2,20–2,65	Stromaufnahme Consom. de courant Power consumption	Ohne Batterie, mit externer Speisung Sans pile, avec alimentation externe Without battery, with external power supply
519, 519S	2	V	≤ 1,30	Funktionskontrolle bei Minimalspannung Contrôle de fonctionnement à tension minimale Check with lowest possible voltage	Ohne Batterie, mit externer Speisung Sans pile, avec alimentation externe Without battery, with external power supply
519 519S	3	KΩ	1,90–2,10 2,35–2,55	Spulenwiderstand Résistance de la bobine Resistance of the coil	Ohne Batterie Sans pile Without battery
519, 519S	4	KΩ	∞	Spulenisolation Isolation de la bobine Coil insulation	Ohne Batterie Sans pile Without battery
519, 519S		Sek./Monat sec./mois sec./month	- 10/+ 20	Induktivsonde 60 Sek. Senseur inductif 60 sec. Inductive sensor 60 sec.	Mit Batterie Avec pile With battery

Einschalen / Werkzeuge

Emboîtage / outils

Casing / tools

Nr. H 51X.1A



Nr. H 51X.1T



	<b>SWISS MADE &amp; SWISS PARTS</b>
Schraube Vis Screw	

**Zeigersetzen**

Maximale Aufpresskraft:

- Stunden und Minutenzeiger: max. 40N
- Sekundenzeiger: max. 30N

Beim Zeigersetzen muss das Werk abgestützt werden.

**Poser les aiguilles**

Force de chassage maximale:

- Aiguilles des heure et des minutes: max. 40N
- Aiguille des secondes: max. 30N

Lors de la pose d'aiguilles, le mouvement doit être soutenu.

**Hand setting**

Maximal force:

- Hour and minute hands: max. 40N
- Second hand: max. 30N

The movement needs to be supported for hand setting.

**Kal. 519 Stellwelle entfernen**

Beim Entfernen der Stellwelle muss sich die Stellwelle in **Position 2** befinden, bevor auf den Winkelhebel gedrückt wird.

**Cal. 519 Enlever la tige**

Enlevant la tige, la tige doit se trouver en **position 2**, avant de pousser sur la tirette.

**Cal. 519 Stem removal**

For removal of the stem, the stem must be in **position 2** prior to apply pressure to the setting lever.