

TECHNICAL GUIDE
&
PARTS CATALOGUE
CaI.VD56C
ANALOGUE QUARTZ

SII Products





PARTS CATALOGUE / TECHNICAL GUIDE

Cal.VD56C

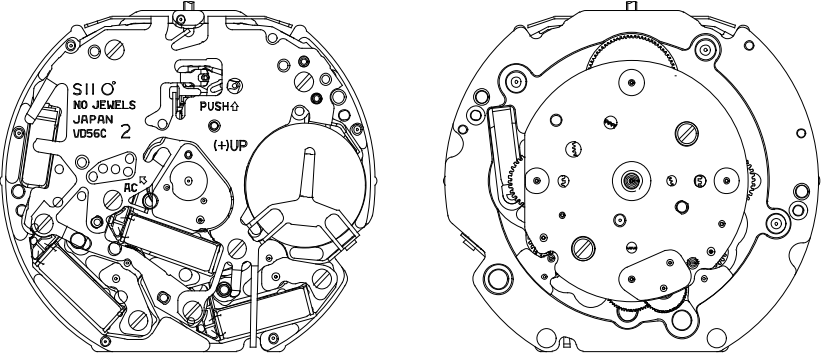
[SPECIFICATION]

Version-01

Item		Cal. No.	VD56C
Movement			
Movement size	Outside diameter	(φD)	(3H - 9H) (12H - 6H)
		$\varphi 29.50 \text{ mm}$	$\times 26.00 \text{ mm} \times \text{—}$
	Casing diameter	(φD)	(3H - 9H) (12H - 6H)
		$\varphi 28.80 \text{ mm}$	$\times \text{—} \times \text{—}$
	Total height		3.97 mm
Time indication			3 Hands (Hour , Minute , Second) Chronograph (Minute , Second , 1/10 second) 24H indicator
Driving System			Two pole stepping motor Step motor 3 pieces
Additional mechanism			Electronic circuit reset switch Second setting device [Time] Indicated by the Hour , Minute , Second and 24-Hour hands [Stop watch] Up to 1 minute in 1/10 second (2 seconds per round) Up to 60 minutes in 1 second split time
Antimagnetic			$\geq 1600 \text{ A/m}$
Accuracy			Less than ± 20 seconds : Monthly rate at normal temperature range
Battery			SR920SW (SEIZAIKEN) Silver oxide battery $\varphi 9.5 \times t 2.0 \text{ mm}$ Battery life is approximately 3 years
Measuring gate by quartz tester			Use 10-second gate *Set the winding stem with crown at the normal position
Jewels			0 Jewel

Disassembling procedures Figs. ① ⇒ ④⑤	Lubricating : Types of oil	Oil quantity
Reassembling procedures Figs. ④⑤ ⇒ ①	 Moebius 9010  Moebius 9030  S-6	 Normal quantity

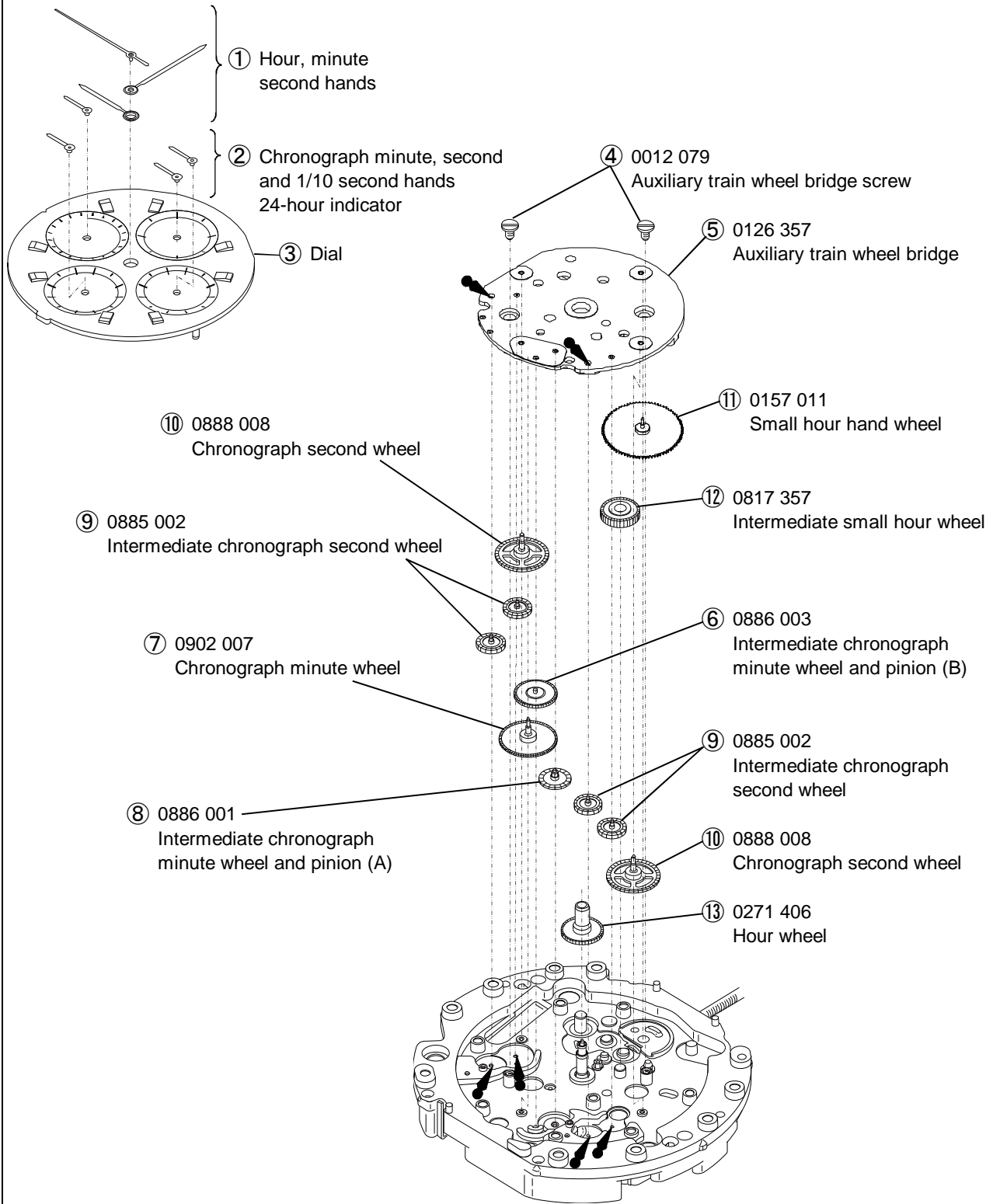

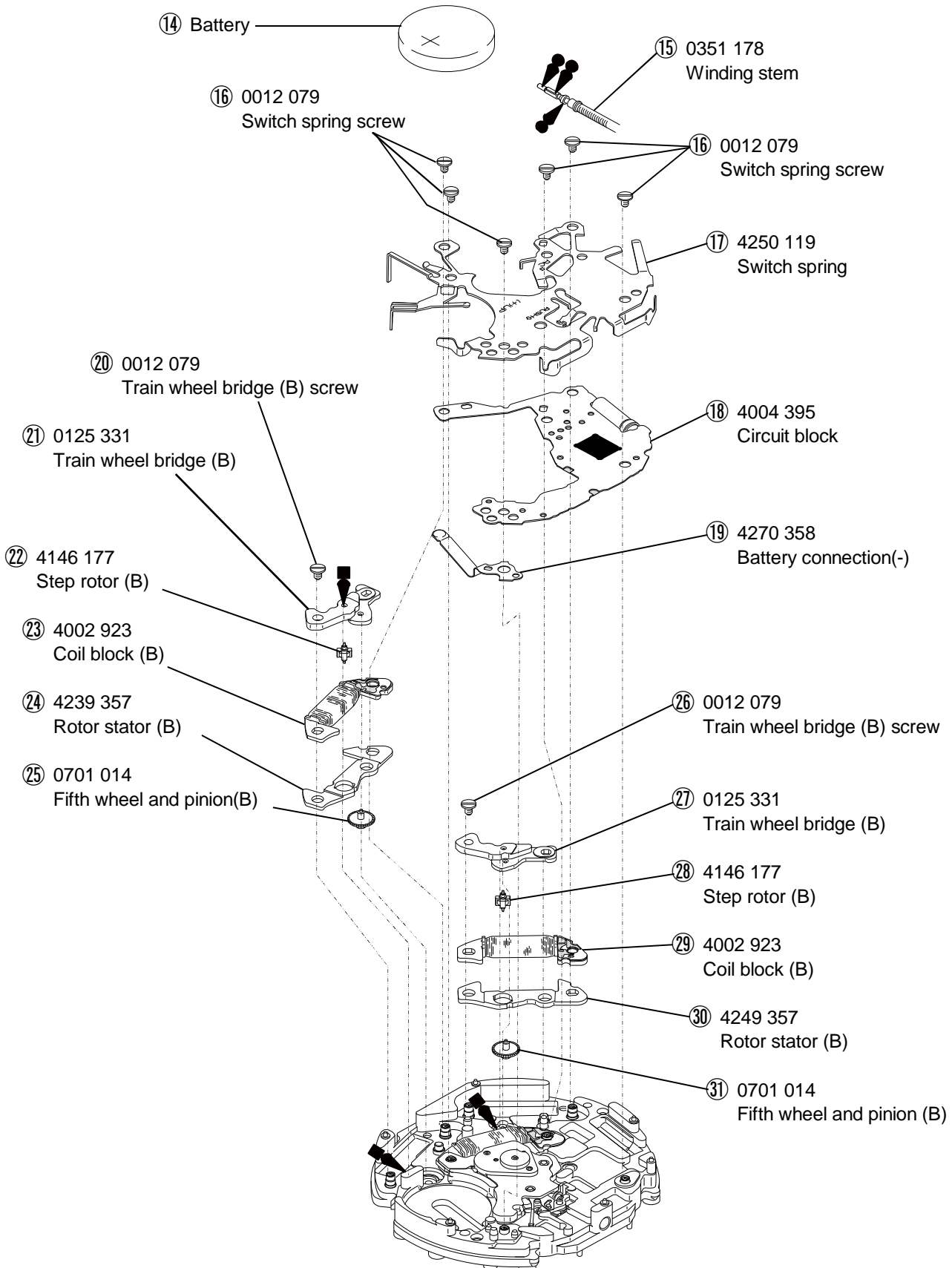

*** All parts code are subject to change without notice.**

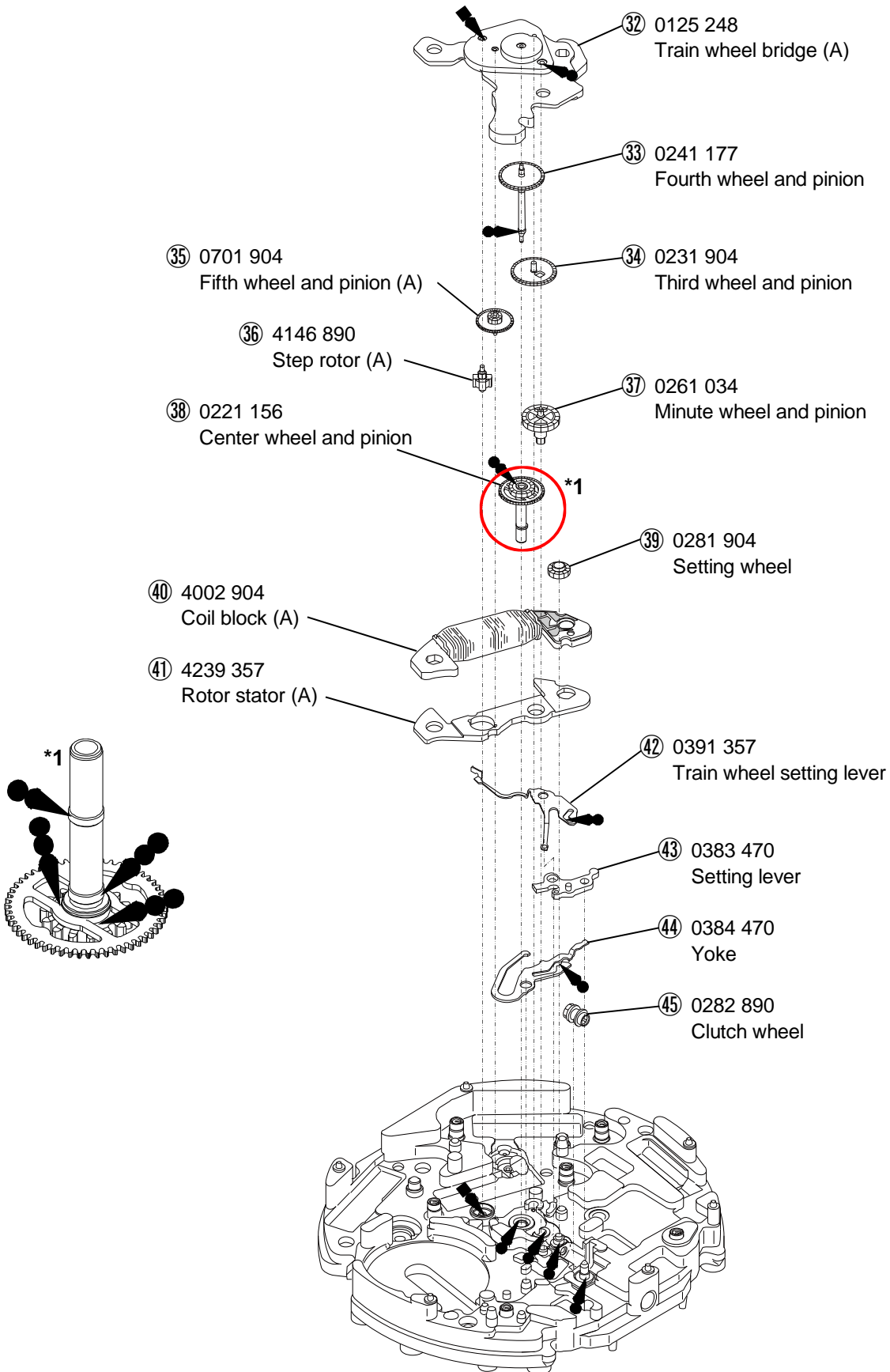

*All parts code are subject to change without notice.

•The explanation here is only for the particular point of Cal.VD56C

1.REMARKS ON INSTALLING THE BATTERY

- 1) After the battery is replaced with a new one or after the battery is reinstalled following the repairing procedures, Be sure to touch the short-circuit the AC terminal of circuit block and the switch spring with conductive tweezers to reset the circuit as illustrated at right.

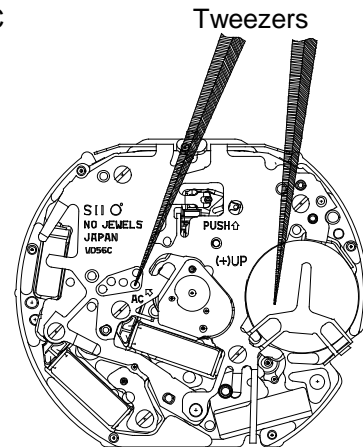

- 2) When the battery replaced with a new one, the time information stored in the built-in IC and the time indicated by the stopwatch hands do not correspond with each other. Reset the stopwatch hands to "0" position following the procedure below. If the stopwatch hands should move improperly, also follow the same procedure.

ORDER

- ① Pull out the crown.
- ② Keep the buttons "A" and "B" pressed at the same time for 2 seconds, and then, release the buttons. The stopwatch second hand move back and returned to where it was.
- ③ Press button "A" or "B" to reset the stopwatch second and minute hands to"0" position.
 - * By pressing button "A", set the stopwatch 1/10 second hand.
 - * By pressing button "B", set the stopwatch second and minute hands.
- ④ Turn the crown to set the hour, and minute and 24-hour hands to the desired time, and push the crown back to the normal position.

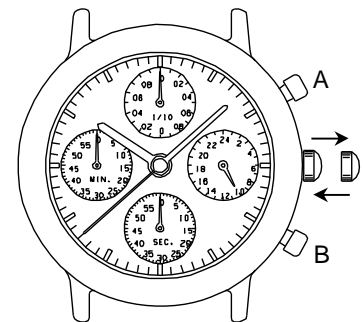

1.REMARKS ON INSTALLING THE BATTERY

(1) HAND

•How to install the hands

Place the movement directly on a flat metal plate or the like and press in the hands.

* Install the hour , minute and second hands at the "12"o'clock position.

* Install the chrono minute and second hands at the "0"o'clock position.

*Install the 24-hour indicator at the "24"position.

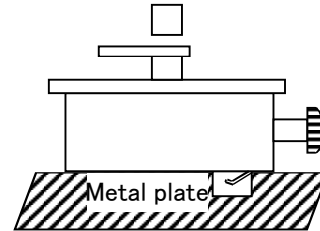

[Reference] The power of press hands

Minute & Hour Hands < 5kg

Second Hand < 5kg

Chrono Minute & Second < 3kg

24-Hour indicator < 3kg

(2) Battery

- ① Remove the hook of the switch springs battery clamp portion.
- ② Insert the battery sideways, and have the hook of the switch springs battery clamp portion catch the main plate.

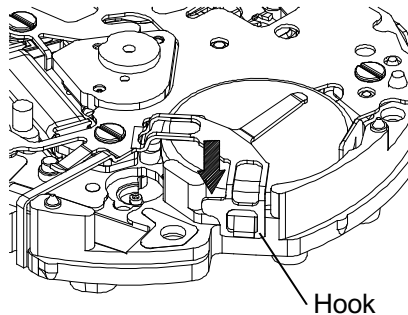

Battery clamp position

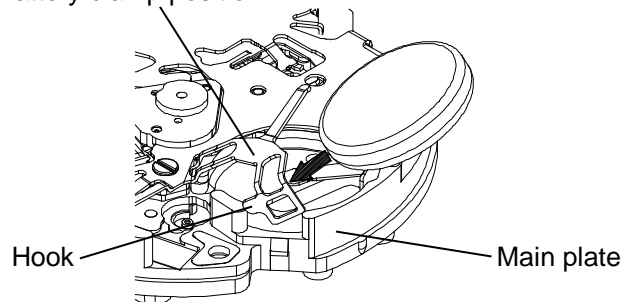

(3) Winding stem

•How to remove

While pushing the indented portion of the arrow pull out the winding stem.

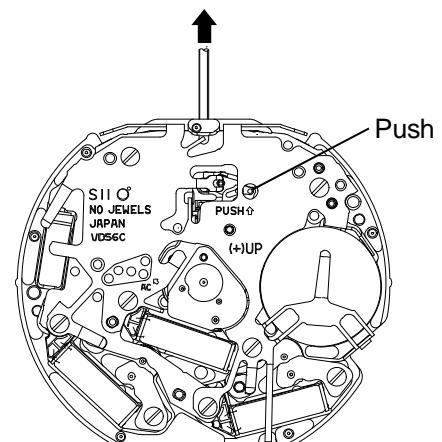

DISPLAY AND CROWN / BUTTON OPERATION

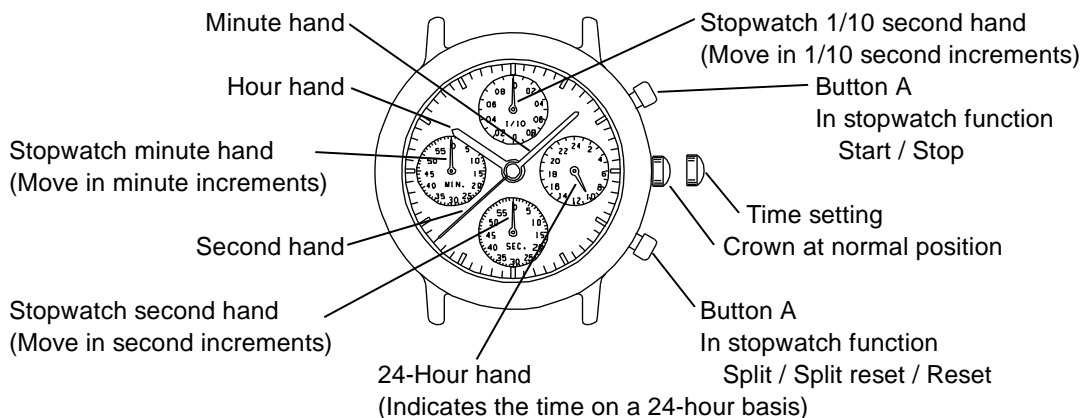

- *The measurement time indicated by the stopwatch hands that move independently of center hands.
- *Stopwatch 1/10 second hand moves for a first minute.
After one minute , it indicates the measurement time when it is stopped.

ADJUSTING THE STOPWATCH HAND POSITION

Before setting the time , check if the stopwatch 1/10 second , second and minute hands are in the "0"(12 o'clock) position.
*If the stopwatch is in use , press the button in the following order to reset it , and then , check if the hands return to "0" position. (For details , see "HOW TO USE THE STOPWATCH")

- * If the stopwatch is counting : A → B
- * If the stopwatch is stopped : B
- * If the split time is displayed : B → A → B

If either of the stopwatch hands are not in the "0" position , reset them following the procedure below.

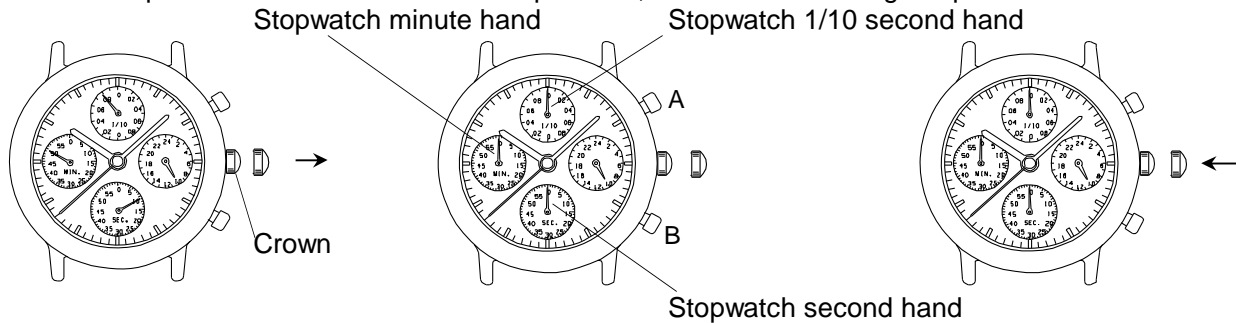

1.Pull out the crown.

2.Press button A or B to reset the stopwatch 1/10 second , second and minute hands to "0"position.
*By pressing button A set the Stopwatch 1/10 second hand.
*By pressing button B set the Stopwatch second and minute hands.

3.Push the crown back to the normal position.

- *The stopwatch minute hand moves correspondingly with the stopwatch second hand.
- *The hands move quickly if the respective buttons are kept pressed.

TIME SETTING

*Before setting the time , check that the chronograph measurement is stopped.

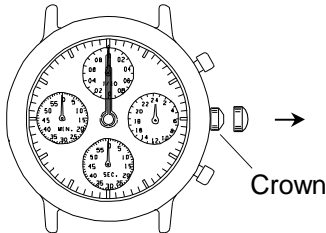

1. Pull out the crown when the second hand is at the 12 o'clock position. The second hand will stop on the spot.

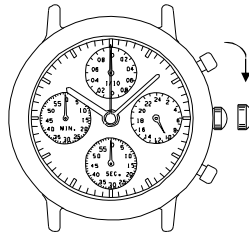

2. Turn the crown to set the hour , minute and 24-hour hands to the desired time. As the hour hand moves, the 24-hour hand also moves correspondingly.

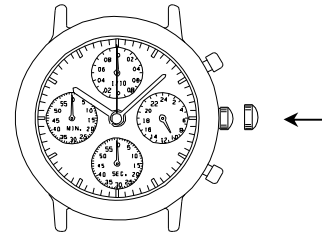

3. Push the crown back in to the normal position in accordance with a time signal.

* Do not press any button. Otherwise, the chronograph hands will move.

When setting the hour hand, check that the 24-hour hand is set property.

HOW TO USE THE STOPWATCH

- The measured time is indicated by the stopwatch hands that move independently of the center hands.
- The stopwatch can measure up to 60 minutes in 1/10 seconds.

(Standard measurement)

Ex) 100m race (Press the buttons in the following order A → A → B)

START → STOP (Finish) → RESET (Reset to "0'00")

Stopwatch minute hand

Stopwatch 1/10 second hand

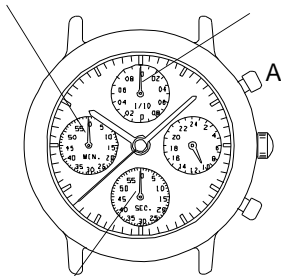

Stopwatch second hand

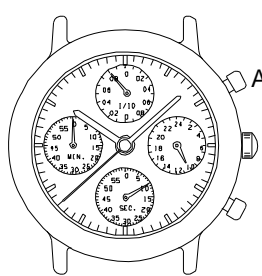

9.8/10 second

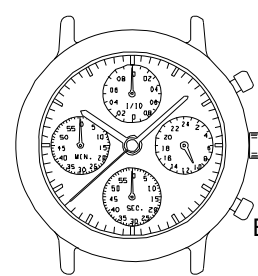

(Accumulated elapsed time measurement)

Ex) Basketball game (Press the buttons in the following order A → A / A ... → A → B)

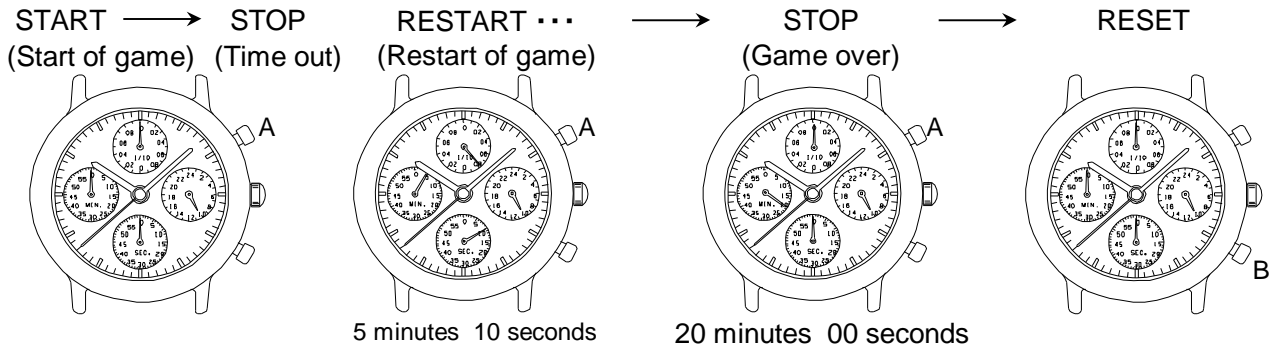

*Restart and stop of the stopwatch can be repeated as many times as necessary by pressing button A.

(Split time measurement)

Ex) 5,000m race (Press the buttons in the following order A → B / B ... → A → B)

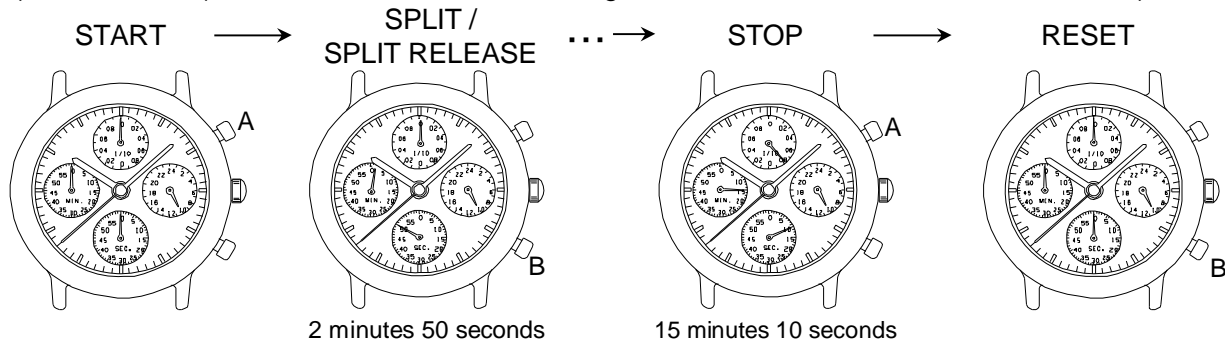

* Measurement and release of the split time can be repeated as many times as necessary by pressing button B.