

# RONDA normtech 700 & 6000

Long battery-life and special functionality

*Caliber 751.24 – 5½'''*

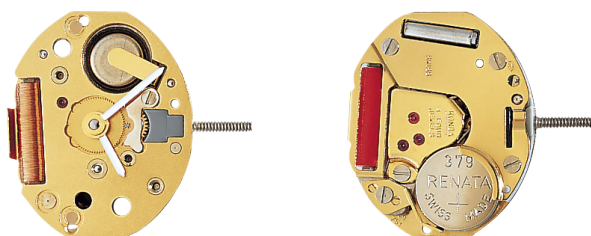

## Product Specifications

Analog quartz movement

Line normtech

Caliber 751.24

Size 5½'''

Version Swiss Made 4 Jewels / gold plated  
Swiss Parts 1 Jewels / nickel plated

Standard battery life 7 Years

Hand fitting height 1

## Features

- Repairable metal watch movement
- Very long battery life
- Power saving mechanism with pulled out stem: Reduction of consumption approximately 70%

**Functions**

- 24 hours
- 2 hands

**Technical Specifications**

Diameter Total	13.00 mm
Case fitting	13.00 mm
Movement height	2.50 mm
Height over standard battery	2.65 mm
Movement rest	0.40 mm
Height over stem	1.00 mm
Length of stem travel	0.40 mm
Force to push the stem for screwed crown	- / - N
Stem thread	0.90 mm
Standard battery	379
Standard battery life	7 Years
Battery voltage	1.5 V
Current consumption – typical	0.24 µA
Current consumption – maximum	0.3 µA
Useful torque minute – typical	250 µNm
Operating temperature	0 - 50 °C
Instantaneous rate	-10/ +20 sec/month
Resistance to magnetic fields	18.8 Oe
Resistance against shock	NIHS 91-10



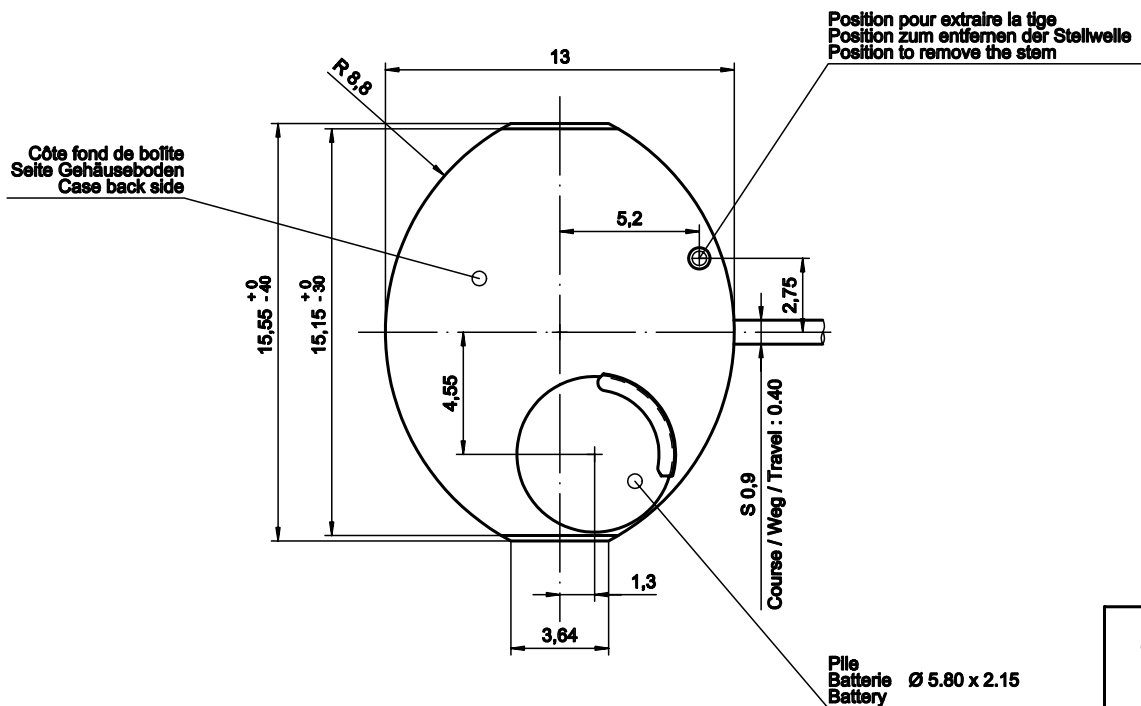
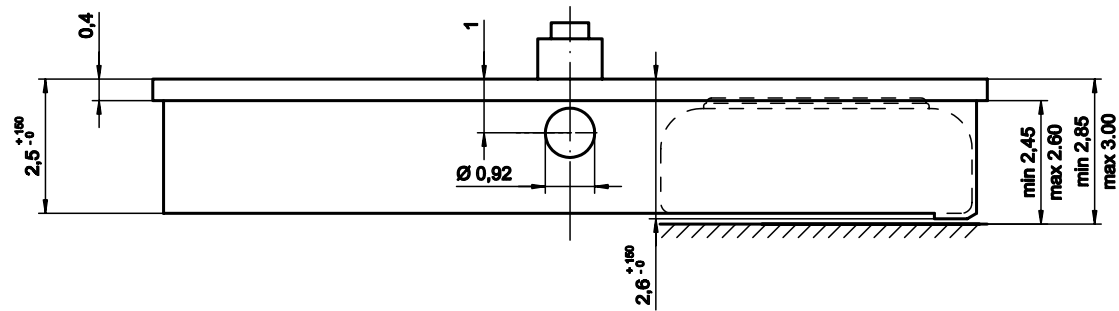

Sécurité entre aiguille minute et verre : min 0.30 mm  
 Sicherheit zwischen Minutenzeiger und Glas : min 0.30 mm  
 Security between minute hand and glass : min 0.30 mm

Le cadran doit être maintenu en hauteur par la boîte.  
 Das Zifferblatt muss in der Höhe vom Gehäuse festgehalten werden.  
 The dial must be held in the height by the case.

<b>Cage</b> <b>Uhrwerkgestell</b> <b>Frame</b>	<b>5½<sup>mm</sup></b>	Issued	21 Jan 1992	rh
		Modified	11. Dez. 2006	cm
		Released	AA —	
		Tolerance	+/- 20 µm	
		Scale	10 : 1 (5 : 1) (A3H)	
<b>RONDA</b>	<b>751.24</b>	Sous réserve de modifications Änderungen vorbehalten Modifications reserved		
		No.	<b>5000.289</b>	<b>07</b>

# Technische Anleitung Instructions techniques No. 303.7 Technical Instructions



5 1/2'''



751/751E

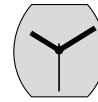

753



751.24

Produktion gestoppt  
 Fin de série  
 Phased out

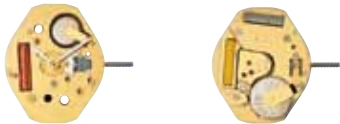

6 3/4 x 8'''

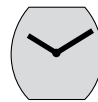

762/762H

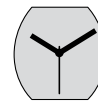

763

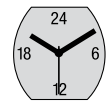

763.24

Produktion gestoppt  
 Fin de série  
 Phased out

## 1. Werkdimensionen

## 1. Dimensions mouvem.

## 1. Movement dims.

Kaliber Calibre Caliber	Ø Total	Ø Werksitz Ø Encageage Ø Case fitting	Werkhöhe Hauteur mouvement Movement height	Höhe Batterie Hauteur pile Height of battery	Höhe Stellwelle Hauteur tige Height of stem	Höhe Werkauflage Hauteur filet Movement rest
Einh./ Unité/ Unit	mm	mm	mm	mm	mm	mm
751/753/751.24/751E	13,00 x 15,55	13,00 x 15,15	2,50	2,65	1,00	0,40
762/763/763.24/762H	15,30 x 18,20	15,30 x 17,80	2,50	2,65	1,00	0,40
Stellwellengewinde / Filetage de la tige / Stem thread: Ø 0,90 mm					Weg / Chemin / Length of travel: 0,40 mm	

## 2. Funktionen

## 2. Fonctions

## 2. Functions

Kaliber Calibre Caliber	Stellwellenpos. Pos. de tige Stem position	Funktionen Fonctions Functions
751/751E/751.24 762/762H	1	Normale Position / Position normale / Running position
	2	Zeiger stellen / Mise à l'heure / Hand setting
753 763 763.24	1	Normale Position / Position normale / Running position
	2	Zeiger stellen, Sekunden-Stopp mit Unterbruch der Motorimpulse Mise à l'heure, stop-seconde avec interruption des impulsions moteur Hand setting, stop-second with interruption of motor pulses

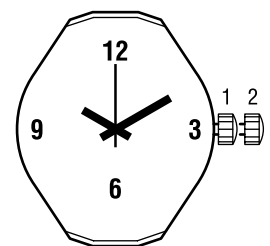

## 3. Leistungen

## 3. Performances

## 3. Performances

Kaliber Calibre Caliber	Bedingungen Conditions Conditions	Momentaner Gang March instantanée Instantaneous rate	Drehmoment Couple utile Torque	Gangreserve Autonomie Autonomy
	Einheit / Unité / Unit Typ. Wert / Valeur / Value	(s/month)	(µNm) typ. sec. min.	(m = Monat/mois/month) (y = Jahr/année/years)
751 / 751.24 / 751E	1,55 V 23°C Batt./Pile 16 mAh	- 10/+ 20	– 36	7 y (*58 m)
753	1,55 V 23°C Batt./Pile 16 mAh	- 10/+ 20	5 250	27 m
762 / 762H	1,55 V 23°C Batt./Pile 20 mAh	- 10/+ 20	– 29	10 y (*87 m)
763 / 763.24	1,55 V 23°C Batt./Pile 20 mAh	- 10/+ 20	5 250	40 m
Magnetfeldabschirmung / Résist. aus champs magn. / Resist. to magnetic fields			18,8 Oe	1500 A/M
Betriebstemperatur / Température d'opération / Operating temperature			0–50°C	
Schockresistenz / Résistance au choc / Shock resistance			NIHS 91–10	

5 1/2''' 751, 753, 751.24, 751E

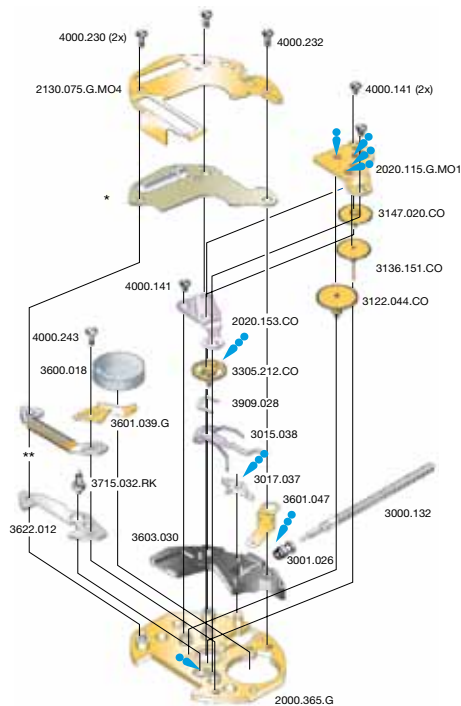

••• Düninflüssiges Öl, z.B. Moebius 9030 (cal. 753)  
 ••• Düninflüssiges Öl, z.B. Moebius 9014 (cal. 751, 751.E)  
 ••• Fett, z.B. Moebius, Microgloss D5, Jisma 124

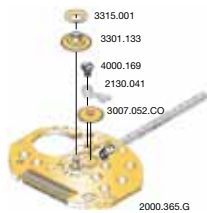

Cal. 753 Werkseite / Côté mouvement / Movement side			
Plan No.	Bestandteile	Fournitures	Spare Parts
2000.365.G	Werkplatte	Platine	Main plate
2020.115.G.M01	Räderwerkbrücke	Pont rouage	Train w. bridge
2020.153.CO	Zentrumbrücke	Pont centre	Centre bridge
2130.075.G.M04	Modul-Abdeckpl.	Couvre module	Module cover pl.
3000.132	Stellwelle	Tige	Stem
3001.026	Kupplungstrieb	Pignon coulant	Sliding pinion
3015.038	Kuppl.-triebhebel	Bascule	Yoke
3017.037	Winkelhebel	Tirette	Setting lever
3122.044.CO	Kleinbodenrad	Roue moyenne	Third wheel
3136.151.CO	Sekundenrad	Roue secondes	Second-wheel
3147.020.CO	Zwischenrad	Roue interméd.	Intermed. wheel
3305.212.CO	Minutenrohr	Chaussée	Cannon pinion
3600.018	Batterie	Pile	Battery
3601.039.G	Batteriehalter	Bride de pile	Battery clamp
3601.047	Batterie-Kontakt	Bride contact	Battery contact
3603.030	Kunststoffzw.teil	Potence plastique	Setting m. cover
*	Modul	Module	Module
**	Spule	Bobine	Coil
3622.012	Stator	Stator	Stator
3715.032.RK	Rotor	Rotor	Rotor
3909.028	K.-trieb.-feder	Clavette bascule	Pillar spring clip
4000.141	Schraube	Vis	Screw
4000.230	Schraube	Vis	Screw
4000.232	Schraube	Vis	Screw
4000.243	Schraube	Vis	Screw

Batterien / Piles / Batteries

751, 753,	Nr. 379	SR 521 SW
751.24, 751E	Dim.Ø x H:	5,8 x 2,1

	751 SWISS MADE	751 SWISS PARTS	753 SWISS MADE	753 SWISS PARTS
* Modul (neu) Module (nouvelle) Module (new)	<b>3612.162</b> grün vert green		<b>3612.152</b> blau bleu blue	<b>3612.163</b> weiss blanc white
** Spule (neu) Bobine (nouvelle) Coil (new)	<b>3621.061.RK</b> gelb jaune yellow			

	751 SWISS MADE	751 SWISS PARTS	753 SWISS MADE	753 SWISS PARTS
* Modul (alt) Module (vieille) Module (old)	<b>3612.063</b> rot rouge red		<b>3612.102</b> gelb jaune yellow	<b>3612.060</b>
** Spule (alt) Bobine (vieille) Coil (old)	<b>3621.014.RK</b> rot rouge red			

Abweichungen / Divergences / Deviations

Cal. 751 Werkseite / Côté mouvement / Movement side			
Plan No.	Bestandteile	Fournitures	Spare Parts
2020.104.CO	Zentrumbrücke	Pont centre	Centre bridge
2020.116.G.M01	Räderwerkbrücke	Pont rouage	Train w. bridge
2130.075.G.M01	Modul-Abdeckpl.	Couvre module	Module cover pl.
3122.045.CO	Kleinbodenrad	Roue moyenne	Third wheel
3305.174.CO	Minutenrohr	Chaussée	Cannon pinion
*	Modul	Module	Module
3622.018	Stator	Stator	Stator

Cal. 751E Werkseite / Côté mouvement / Movement side			
Plan No.	Bestandteile	Fournitures	Spare Parts
3305.198.CO	Minutenrohr	Chaussée	Cannon pinion

Cal. 751, 753 Zifferblattseite / Côté cadran / Dial side			
Plan No.	Bestandteile	Fournitures	Spare Parts
2130.041	Zeigerwerkplatte	Plaque maintien	Maintaining plate
3007.052.CO	Wechselrad	Minuterie	Minute wheel
3301.133	Stundenrad	Canon	Hour wheel
3315.001	Spreizfeder 2 1/2	Clinquant 2 1/2	Washer 2 1/2
4000.169	Schraube	Vis	Screw

Cal. 751E Zifferblattseite / Côté cadran / Dial side			
Plan No.	Bestandteile	Fournitures	Spare Parts
3301.176	Stundenrad	Canon	Hour wheel

Cal. 751.24 Zifferblattseite / Côté cadran / Dial side			
Plan No.	Bestandteile	Fournitures	Spare Parts
2130.102	Zeigerwerkplatte	Plaque maintien	Maintaining plate
3007.043.CO	Wechselrad	Minuterie	Minute wheel
3301.194	Stundenrad	Canon	Hour wheel

6 3/4 x 8''' 762, 763, 763.24, 762H

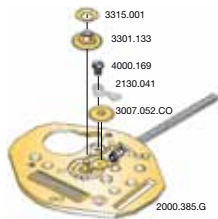
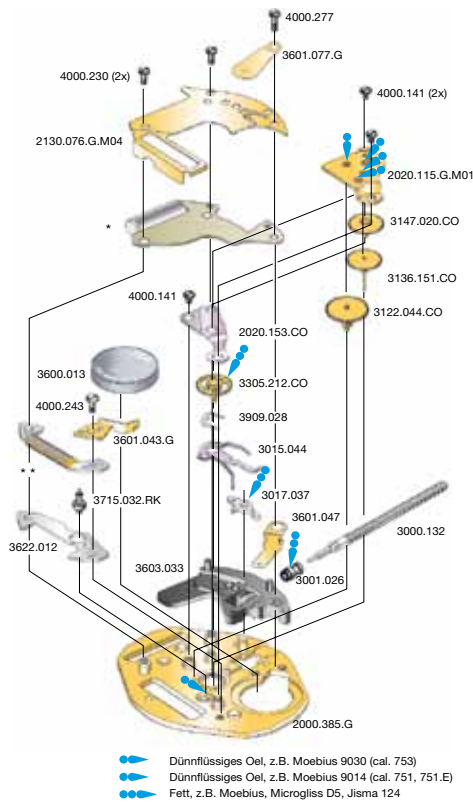

Cal. 763	Werkseite / Côté mouvement / Movement side		
Plan No.	Bestandteile	Fournitures	Spare Parts
2000.385.G	Werkplatte	Platine	Main plate
2020.115.G.M01	Räderwerkbrücke	Pont rouage	Train w. bridge
2020.153.CO	Zentrumbrücke	Pont centre	Centre bridge
2130.076.G.M04	Modul-Abdeckpl.	Couvre module	Module cover pl.
3000.132	Stellwelle	Tige	Stem
3001.026	Kupplungstrieb	Pignon coulant	Sliding pinion
3015.044	Kuppl.-triebhebel	Bascule	Yoke
3017.037	Winkelhebel	Tirette	Setting lever
3122.044.CO	Kleinbodenrad	Roue moyenne	Third wheel
3136.151.CO	Sekundenrad	Roue secondes	Second-wheel
3147.020.CO	Zwischenrad	Roue interméd.	Intermed. wheel
3305.212.CO	Minutenrohr	Chaussée	Cannon pinion
3600.013	Batterie	Pile	Battery
3601.043.G	Batteriehalter	Bride pile	Battery clamp
3601.047	Batt.-Kontakt	Bride contact	Battery contact
3601.077.G	Batteriehalter	Bride pile	Battery clamp
3603.033	Kunststoffzw.teil	Potence plastique	Setting m. cover
*	Modul	Module	Module
**	Spule	Bobine	Coil
3622.012	Stator	Stator	Stator
3715.032.RK	Rotor	Rotor	Rotor
3909.028	K.-triebhebel	Clavette bascule	Pillar spring clip
4000.141	Schraube	Vis	Screw
4000.230	Schraube	Vis	Screw
4000.243	Schraube	Vis	Screw
4000.277	Schraube	Vis	Screw

	762 SWISS MADE	762 SWISS PARTS	763 SWISS MADE	763 SWISS PARTS
* <b>Modul (neu)</b> <b>Module (nouvelle)</b> <b>Module (new)</b>	<b>3612.159</b> grün vert green		<b>3612.160</b> blau bleu blue	<b>3612.151</b> weiss blanc white
** <b>Spule (neu)</b> <b>Bobine (nouvelle)</b> <b>Coil (new)</b>	<b>3621.061.RK</b> gelb jaune yellow			

	762 SWISS MADE	762 SWISS PARTS	763 SWISS MADE	763 SWISS PARTS
* <b>Modul (alt)</b> <b>Module (vieille)</b> <b>Module (old)</b>	<b>3612.096</b> rot rouge red		<b>3612.112</b> gelb jaune yellow	<b>3612.076</b>
** <b>Spule (alt)</b> <b>Bobine (vieille)</b> <b>Coil (old)</b>	<b>3621.014.RK</b> rot rouge red			

Abweichungen / Divergences / Deviations

Cal. 762	Werkseite / Côté mouvement / Movement side		
Plan No.	Bestandteile	Fournitures	Spare Parts
2020.104.CO	Zentrumbrücke	Pont centre	Centre bridge
2020.116.G.M01	Räderwerkbrücke	Pont rouage	Train w. bridge
2130.076.G.M01	Modul-Abdeckpl.	Couvre module	Module cover pl.
3122.045.CO	Kleinbodenrad	Roue moyenne	Third wheel
3305.174.CO	Minutenrohr	Chaussée	Cannon pinion
* 3622.018	Modul Stator	Module Stator	Module Stator

Cal. 762H	Werkseite / Côté mouvement / Movement side		
Plan No.	Bestandteile	Fournitures	Spare Parts
3305.198.CO	Minutenrohr	Chaussée	Cannon pinion

Cal. 762, 763	Zifferblattseite / Côté cadran / Dial side		
Plan No.	Bestandteile	Fournitures	Spare Parts
2130.041	Zeigerwerkplatte	Plaque maintien	Maintaining plate
3007.052.CO	Wechselrad	Minuterie	Minute wheel
3301.133	Stundenrad	Canon	Hour wheel
3315.001	Spreifeder 2 1/2	Clinquant 2 1/2	Washer 2 1/2
4000.169	Schraube	Vis	Screw

Cal. 762H	Zifferblattseite / Côté cadran / Dial side		
Plan No.	Bestandteile	Fournitures	Spare Parts
3301.176	Stundenrad	Canon	Hour wheel

Cal. 763.24	Zifferblattseite / Côté cadran / Dial side		
Plan No.	Bestandteile	Fournitures	Spare Parts
2130.102	Zeigerwerkplatte	Plaque maintien	Maintaining plate
3007.043.CO	Wechselrad	Minuterie	Minute wheel
3301.194	Stundenrad	Canon	Hour wheel

Batterien / Piles / Batteries

762, 762H, 763, 763.24	Nr. 364 Dim.Ø x H:	SR 621 SW 6,80 x 2,1
------------------------	-----------------------	-------------------------

## 4. Elektr. Messungen

## 4. Contrôles électriques

## 4. Electrical checking

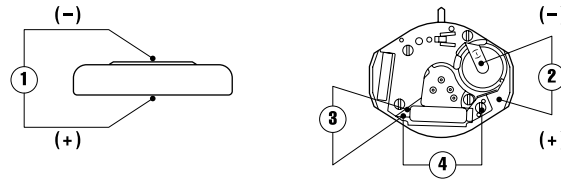

Kaliber Calibre Caliber	Pos. Pos. Pos.	Einheit Unité Unit	Messwerte Valeurs mesurées Measured values	Kontrolle Contrôle Check	Bemerkungen Remarques Remarks
751-763 751E, 762H	1	V	1,55	Batterie-Spannung Tension de la pile Battery voltage	Batterie herausnehmen und messen Enlever et mesurer la pile Remove battery for measuring
751, 751E, 762, 762H Puls/10 sec., impulsion/10s., pulse/10 sec.		µA	0,20-0,50 ~ 1,3-2,2	Stromaufnahme Consommation de courant Current consumption	Ohne Batterie, mit externer Speisung Sans pile, avec alimentation externe Without battery, with external power supply
753-763		µA	0,70-1,10		
751-763 751E, 762H	2	V	≤ 1,30	Funktionskontrolle bei Minimalspannung Contrôle de fonctionnement à tension min. Check with lowest possible voltage	Ohne Batterie, mit externer Speisung Sans pile, avec alimentation externe Without battery, with external power supply
751-763 751E, 762H	3	KΩ	1,40-1,60 (2,60-2,90*)	Spulenwiderstand Résistance de la bobine Resistance of the coil	Ohne Batterie Sans pile Without battery
751-763 751E, 762H	4	KΩ	∞	Spulenisolation Isolation de la bobine Coil insulation	Ohne Batterie Sans pile Without battery
751-763 751E, 762H		Sek./Monat sec./mois sec./month	- 10/+ 20	Induktivsonde 60 Sek. Senseur inductif 60 sec. Inductive sensor 60 sec.	Mit Batterie Avec pile With battery

Werte (\*) gelten für rote Spule (s. Seite 2 und 3)

Valeurs (\*) sont valid pour bobine rouge (v. page 2 et 3)

Values (\*) are valid for red coil (see pages 2 and 3)

## 5. Einschalen / Werkzeuge

## 5. Emboîtage / outils

## 5. Casing / tools

Nr. H 75x.1A



Nr. H 76x.1A



Nr. H 75x.1T



Nr. H 76x.1T



**	SWISS MADE & SWISS PARTS
Schraube Vis Screw	

### Zeiger setzen

Maximale Aufpresskraft:

- Stunden und Minutenzeiger: max. 40N
- Sekundenzeiger: max. 30N

Beim Zeiger setzen muss das Werk abgestützt werden.

### Poser les aiguilles

Force de chassage maximale:

- Aiguilles des heure et des minutes: max. 40N
- Aiguille des secondes: max. 30N

Lors de la pose d'aiguilles, le mouvement doit être soutenu.

### Hand setting

Maximal force:

- Hour and minute hands: max. 40N
- Second hand: max. 30N

The movement needs to be supported for hand setting.

### Stellwelle entfernen

Beim Entfernen der Stellwelle muss sich die Stellwelle in Position 1 (gedrückt) befinden, bevor auf den Winkelhebel gedrückt wird.

### Enlever la tige

En enlevant la tige, la tige doit se trouver en position 1 (poussée), avant de pousser sur la tirette.

### Stem removal

For removal of the stem, the stem must be pushed into position 1 (pressed in) prior to apply pressure to the setting lever.

# Technische Anleitung Instructions techniques No. 303.7 Technical Instructions



5 1/2'''

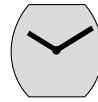

751/751E

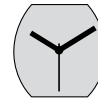

753



751.24

Produktion gestoppt  
 Fin de série  
 Phased out



6 3/4 x 8'''



762/762H

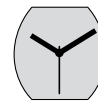

763

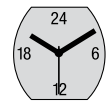

763.24

Produktion gestoppt  
 Fin de série  
 Phased out

## 1. Werkdimensionen

## 1. Dimensions mouvem.

## 1. Movement dims.

Kaliber Calibre Caliber	Ø Total	Ø Werksitz Ø Encageage Ø Case fitting	Werkhöhe Hauteur mouvement Movement height	Höhe Batterie Hauteur pile Height of battery	Höhe Stellwelle Hauteur tige Height of stem	Höhe Werkauflage Hauteur filet Movement rest
Einh./ Unité/ Unit	mm	mm	mm	mm	mm	mm
751/753/751.24/751E	13,00 x 15,55	13,00 x 15,15	2,50	2,65	1,00	0,40
762/763/763.24/762H	15,30 x 18,20	15,30 x 17,80	2,50	2,65	1,00	0,40
Stellwellengewinde / Filetage de la tige / Stem thread: Ø 0,90 mm					Weg / Chemin / Length of travel: 0,40 mm	

## 2. Funktionen

## 2. Fonctions

## 2. Functions

Kaliber Calibre Caliber	Stellwellenpos. Pos. de tige Stem position	Funktionen Fonctions Functions
751/751E/751.24 762/762H	1	Normale Position / Position normale / Running position
	2	Zeiger stellen / Mise à l'heure / Hand setting
753 763 763.24	1	Normale Position / Position normale / Running position
	2	Zeiger stellen, Sekunden-Stopp mit Unterbruch der Motorimpulse Mise à l'heure, stop-seconde avec interruption des impulsions moteur Hand setting, stop-second with interruption of motor pulses

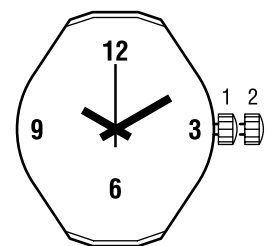

## 3. Leistungen

## 3. Performances

## 3. Performances

Kaliber Calibre Caliber	Bedingungen Conditions Conditions	Momentaner Gang March instantanée Instantaneous rate	Drehmoment Couple utile Torque	Gangreserve Autonomie Autonomy
	Einheit / Unité / Unit Typ. Wert / Valeur / Value	(s/month)	(µNm) typ. sec. min.	(m = Monat/mois/month) (y = Jahr/année/years)
751 / 751.24 / 751E	1,55 V 23°C Batt./Pile 16 mAh	- 10/+ 20	– 36	7 y (*58 m)
753	1,55 V 23°C Batt./Pile 16 mAh	- 10/+ 20	5 250	27 m
762 / 762H	1,55 V 23°C Batt./Pile 20 mAh	- 10/+ 20	– 29	10 y (*87 m)
763 / 763.24	1,55 V 23°C Batt./Pile 20 mAh	- 10/+ 20	5 250	40 m
Magnetfeldabschirmung / Résist. aus champs magn. / Resist. to magnetic fields			18,8 Oe	1500 A/M
Betriebstemperatur / Température d'opération / Operating temperature			0–50°C	
Schockresistenz / Résistance au choc / Shock resistance			NIHS 91–10	

# Werkaufbau

# Assemblage

# Assembling

5 1/2''' 751, 753, 751.24, 751E

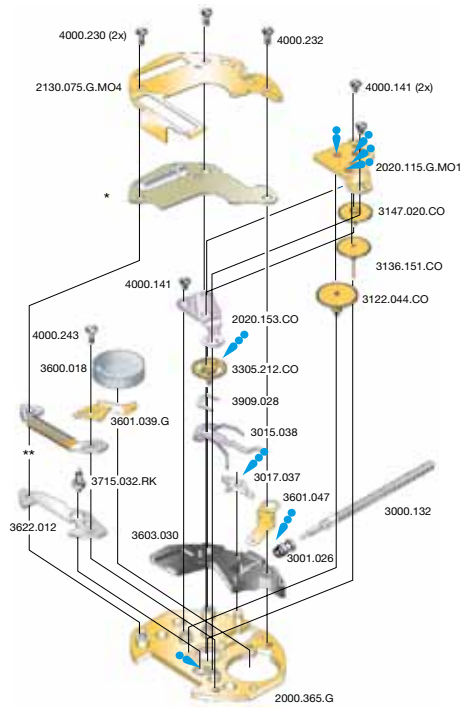

- Düninflüssiges Öl, z.B. Moebius 9030 (cal. 753)
- Düninflüssiges Öl, z.B. Moebius 9014 (cal. 751, 751.E)
- Fett, z.B. Moebius, Microgloss D5, Jisma 124



Cal. 753 Werkseite / Côté mouvement / Movement side			
Plan No.	Bestandteile	Fournitures	Spare Parts
2000.365.G	Werkplatte	Platine	Main plate
2020.115.G.M01	Räderwerkbrücke	Pont rouage	Train w. bridge
2020.153.CO	Zentrumbrücke	Pont centre	Centre bridge
2130.075.G.M04	Modul-Abdeckpl.	Couvre module	Module cover pl.
3000.132	Stellwelle	Tige	Stem
3001.026	Kupplungstrieb	Pignon coulant	Sliding pinion
3015.038	Kuppl.-triebhebel	Bascule	Yoke
3017.037	Winkelhebel	Tirette	Setting lever
3122.044.CO	Kleinbodenrad	Roue moyenne	Third wheel
3136.151.CO	Sekundenrad	Roue secondes	Second-wheel
3147.020.CO	Zwischenrad	Roue interméd.	Intermed. wheel
3305.212.CO	Minutenrohr	Chaussée	Cannon pinion
3600.018	Batterie	Pile	Battery
3601.039.G	Batteriehalter	Bride de pile	Battery clamp
3601.047	Batterie-Kontakt	Bride contact	Battery contact
3603.030	Kunststoffzw.teil	Potence plastique	Setting m. cover
*	Modul	Module	Module
**	Spule	Bobine	Coil
3622.012	Stator	Stator	Stator
3715.032.RK	Rotor	Rotor	Rotor
3909.028	K.-trieb.-feder	Clavette bascule	Pillar spring clip
4000.141	Schraube	Vis	Screw
4000.230	Schraube	Vis	Screw
4000.232	Schraube	Vis	Screw
4000.243	Schraube	Vis	Screw

## Batterien / Piles / Batteries

751, 753,	Nr. 379	SR 521 SW
751.24, 751E	Dim.Ø x H:	5,8 x 2,1

	751 SWISS MADE	751 SWISS PARTS	753 SWISS MADE	753 SWISS PARTS
* Modul (neu) Module (nouvelle) Module (new)	<b>3612.162</b> grün vert green		<b>3612.152</b> blau bleu blue	<b>3612.163</b> weiss blanc white
** Spule (neu) Bobine (nouvelle) Coil (new)	<b>3621.061.RK</b> gelb jaune yellow			

	751 SWISS MADE	751 SWISS PARTS	753 SWISS MADE	753 SWISS PARTS
* Modul (alt) Module (viele) Module (old)	<b>3612.063</b> rot rouge red		<b>3612.102</b> gelb jaune yellow	<b>3612.060</b>
** Spule (alt) Bobine (viele) Coil (old)	<b>3621.014.RK</b> rot rouge red			

## Abweichungen / Divergences / Deviations

Cal. 751 Werkseite / Côté mouvement / Movement side			
Plan No.	Bestandteile	Fournitures	Spare Parts
2020.104.CO	Zentrumbrücke	Pont centre	Centre bridge
2020.116.G.M01	Räderwerkbrücke	Pont rouage	Train w. bridge
2130.075.G.M01	Modul-Abdeckpl.	Couvre module	Module cover pl.
3122.045.CO	Kleinbodenrad	Roue moyenne	Third wheel
3305.174.CO	Minutenrohr	Chaussée	Cannon pinion
*	Modul	Module	Module
3622.018	Stator	Stator	Stator

Cal. 751E Werkseite / Côté mouvement / Movement side			
Plan No.	Bestandteile	Fournitures	Spare Parts
3305.198.CO	Minutenrohr	Chaussée	Cannon pinion

Cal. 751, 753 Zifferblattseite / Côté cadran / Dial side			
Plan No.	Bestandteile	Fournitures	Spare Parts
2130.041	Zeigerwerkplatte	Plaque maintien	Maintaining plate
3007.052.CO	Wechselrad	Minuterie	Minute wheel
3301.133	Stundenrad	Canon	Hour wheel
3315.001	Spreizfeder 2 1/2	Clinquant 2 1/2	Washer 2 1/2
4000.169	Schraube	Vis	Screw

Cal. 751E Zifferblattseite / Côté cadran / Dial side			
Plan No.	Bestandteile	Fournitures	Spare Parts
3301.176	Stundenrad	Canon	Hour wheel

Cal. 751.24 Zifferblattseite / Côté cadran / Dial side			
Plan No.	Bestandteile	Fournitures	Spare Parts
2130.102	Zeigerwerkplatte	Plaque maintien	Maintaining plate
3007.043.CO	Wechselrad	Minuterie	Minute wheel
3301.194	Stundenrad	Canon	Hour wheel

6 3/4 x 8''' 762, 763, 763.24, 762H

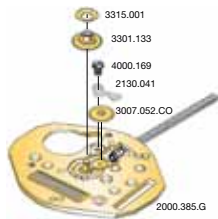
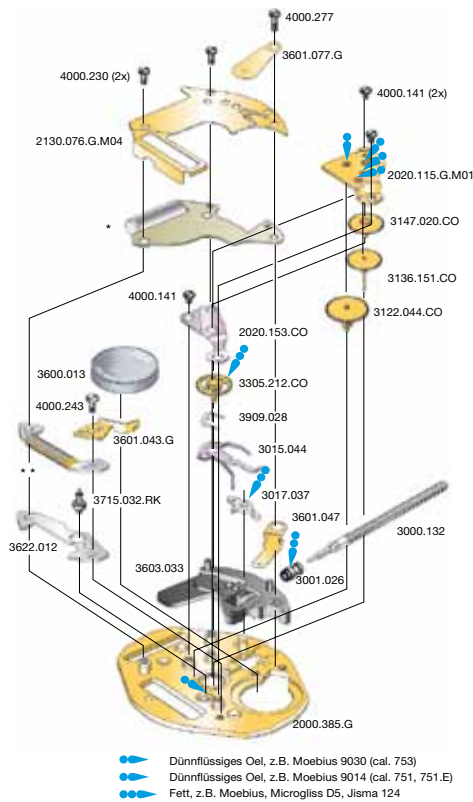

Cal. 763	Werkseite / Côté mouvement / Movement side		
Plan No.	Bestandteile	Fournitures	Spare Parts
2000.385.G	Werkplatte	Platine	Main plate
2020.115.G.M01	Räderwerkbrücke	Pont rouage	Train w. bridge
2020.153.CO	Zentrumbrücke	Pont centre	Centre bridge
2130.076.G.M04	Modul-Abdeckpl.	Couvre module	Module cover pl.
3000.132	Stellwelle	Tige	Stem
3001.026	Kupplungstrieb	Pignon coulant	Sliding pinion
3015.044	Kuppl.-triebhebel	Bascule	Yoke
3017.037	Winkelhebel	Tirette	Setting lever
3122.044.CO	Kleinbodenrad	Roue moyenne	Third wheel
3136.151.CO	Sekundenrad	Roue secondes	Second-wheel
3147.020.CO	Zwischenrad	Roue interméd.	Intermed. wheel
3305.212.CO	Minutenrohr	Chaussée	Cannon pinion
3600.013	Batterie	Pile	Battery
3601.043.G	Batteriehalter	Bride pile	Battery clamp
3601.047	Batt.-Kontakt	Bride contact	Battery contact
3601.077.G	Batteriehalter	Bride pile	Battery clamp
3603.033	Kunststoffzw.teil	Potence plastique	Setting m. cover
*	Modul	Module	Module
**	Spule	Bobine	Coil
3622.012	Stator	Stator	Stator
3715.032.RK	Rotor	Rotor	Rotor
3909.028	K.-triebhebel	Clavette bascule	Pillar spring clip
4000.141	Schraube	Vis	Screw
4000.230	Schraube	Vis	Screw
4000.243	Schraube	Vis	Screw
4000.277	Schraube	Vis	Screw

	762 SWISS MADE	762 SWISS PARTS	763 SWISS MADE	763 SWISS PARTS
* <b>Modul (neu)</b> <b>Module (nouvelle)</b> <b>Module (new)</b>	<b>3612.159</b> grün vert green		<b>3612.160</b> blau bleu blue	<b>3612.151</b> weiss blanc white
** <b>Spule (neu)</b> <b>Bobine (nouvelle)</b> <b>Coil (new)</b>	<b>3621.061.RK</b> gelb jaune yellow			

	762 SWISS MADE	762 SWISS PARTS	763 SWISS MADE	763 SWISS PARTS
* <b>Modul (alt)</b> <b>Module (vieille)</b> <b>Module (old)</b>	<b>3612.096</b> rot rouge red		<b>3612.112</b> gelb jaune yellow	<b>3612.076</b>
** <b>Spule (alt)</b> <b>Bobine (vieille)</b> <b>Coil (old)</b>	<b>3621.014.RK</b> rot rouge red			

Abweichungen / Divergences / Deviations

Cal. 762	Werkseite / Côté mouvement / Movement side		
Plan No.	Bestandteile	Fournitures	Spare Parts
2020.104.CO	Zentrumbrücke	Pont centre	Centre bridge
2020.116.G.M01	Räderwerkbrücke	Pont rouage	Train w. bridge
2130.076.G.M01	Modul-Abdeckpl.	Couvre module	Module cover pl.
3122.045.CO	Kleinbodenrad	Roue moyenne	Third wheel
3305.174.CO	Minutenrohr	Chaussée	Cannon pinion
* 3622.018	Modul Stator	Module Stator	Module Stator

Cal. 762H	Werkseite / Côté mouvement / Movement side		
Plan No.	Bestandteile	Fournitures	Spare Parts
3305.198.CO	Minutenrohr	Chaussée	Cannon pinion

Cal. 762, 763	Zifferblattseite / Côté cadran / Dial side		
Plan No.	Bestandteile	Fournitures	Spare Parts
2130.041	Zeigerwerkplatte	Plaque maintien	Maintaining plate
3007.052.CO	Wechselrad	Minuterie	Minute wheel
3301.133	Stundenrad	Canon	Hour wheel
3315.001	Spreizfeder 2 1/2	Clinquant 2 1/2	Washer 2 1/2
4000.169	Schraube	Vis	Screw

Cal. 762H	Zifferblattseite / Côté cadran / Dial side		
Plan No.	Bestandteile	Fournitures	Spare Parts
3301.176	Stundenrad	Canon	Hour wheel

Cal. 763.24	Zifferblattseite / Côté cadran / Dial side		
Plan No.	Bestandteile	Fournitures	Spare Parts
2130.102	Zeigerwerkplatte	Plaque maintien	Maintaining plate
3007.043.CO	Wechselrad	Minuterie	Minute wheel
3301.194	Stundenrad	Canon	Hour wheel

Batterien / Piles / Batteries

762, 762H, 763, 763.24	Nr. 364 Dim.Ø x H:	SR 621 SW 6,80 x 2,1
------------------------	-----------------------	-------------------------

## 4. Elektr. Messungen

## 4. Contrôles électriques

## 4. Electrical checking

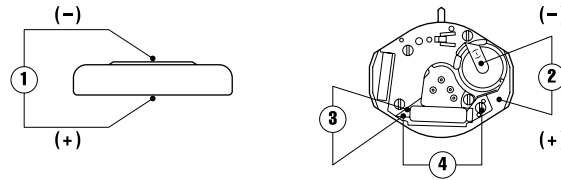

Kaliber Calibre Caliber	Pos. Pos. Pos.	Einheit Unité Unit	Messwerte Valeurs mesurées Measured values	Kontrolle Contrôle Check	Bemerkungen Remarques Remarks
751-763 751E, 762H	1	V	1,55	Batterie-Spannung Tension de la pile Battery voltage	Batterie herausnehmen und messen Enlever et mesurer la pile Remove battery for measuring
751, 751E, 762, 762H Puls/10 sec., impulsion/10s., pulse/10 sec.		µA	0,20-0,50 ~ 1,3-2,2	Stromaufnahme Consommation de courant Current consumption	Ohne Batterie, mit externer Speisung Sans pile, avec alimentation externe Without battery, with external power supply
753-763		µA	0,70-1,10		
751-763 751E, 762H	2	V	≤ 1,30	Funktionskontrolle bei Minimalspannung Contrôle de fonctionnement à tension min. Check with lowest possible voltage	Ohne Batterie, mit externer Speisung Sans pile, avec alimentation externe Without battery, with external power supply
751-763 751E, 762H	3	KΩ	1,40-1,60 (2,60-2,90*)	Spulenwiderstand Résistance de la bobine Resistance of the coil	Ohne Batterie Sans pile Without battery
751-763 751E, 762H	4	KΩ	∞	Spulenisolation Isolation de la bobine Coil insulation	Ohne Batterie Sans pile Without battery
751-763 751E, 762H		Sek./Monat sec./mois sec./month	- 10/+ 20	Induktivsonde 60 Sek. Senseur inductif 60 sec. Inductive sensor 60 sec.	Mit Batterie Avec pile With battery

Werte (\*) gelten für rote Spule (s. Seite 2 und 3)

Valeurs (\*) sont valid pour bobine rouge (v. page 2 et 3)

Values (\*) are valid for red coil (see pages 2 and 3)

## 5. Einschalen / Werkzeuge

## 5. Emboîtement / outils

## 5. Casing / tools

Nr. H 75x.1A



Nr. H 76x.1A



Nr. H 75x.1T



Nr. H 76x.1T



**	SWISS MADE & SWISS PARTS
Schraube Vis Screw	

### Zeiger setzen

Maximale Aufpresskraft:

- Stunden und Minutenzeiger: max. 40N
- Sekundenzeiger: max. 30N

Beim Zeiger setzen muss das Werk abgestützt werden.

### Poser les aiguilles

Force de chassage maximale:

- Aiguilles des heure et des minutes: max. 40N
- Aiguille des secondes: max. 30N

Lors de la pose d'aiguilles, le mouvement doit être soutenu.

### Hand setting

Maximal force:

- Hour and minute hands: max. 40N
- Second hand: max. 30N

The movement needs to be supported for hand setting.

### Stellwelle entfernen

Beim Entfernen der Stellwelle muss sich die Stellwelle in Position 1 (gedrückt) befinden, bevor auf den Winkelhebel gedrückt wird.

### Enlever la tige

En enlevant la tige, la tige doit se trouver en position 1 (poussée), avant de pousser sur la tirette.

### Stem removal

For removal of the stem, the stem must be pushed into position 1 (pressed in) prior to apply pressure to the setting lever.